

# WETROOMS & GLASS

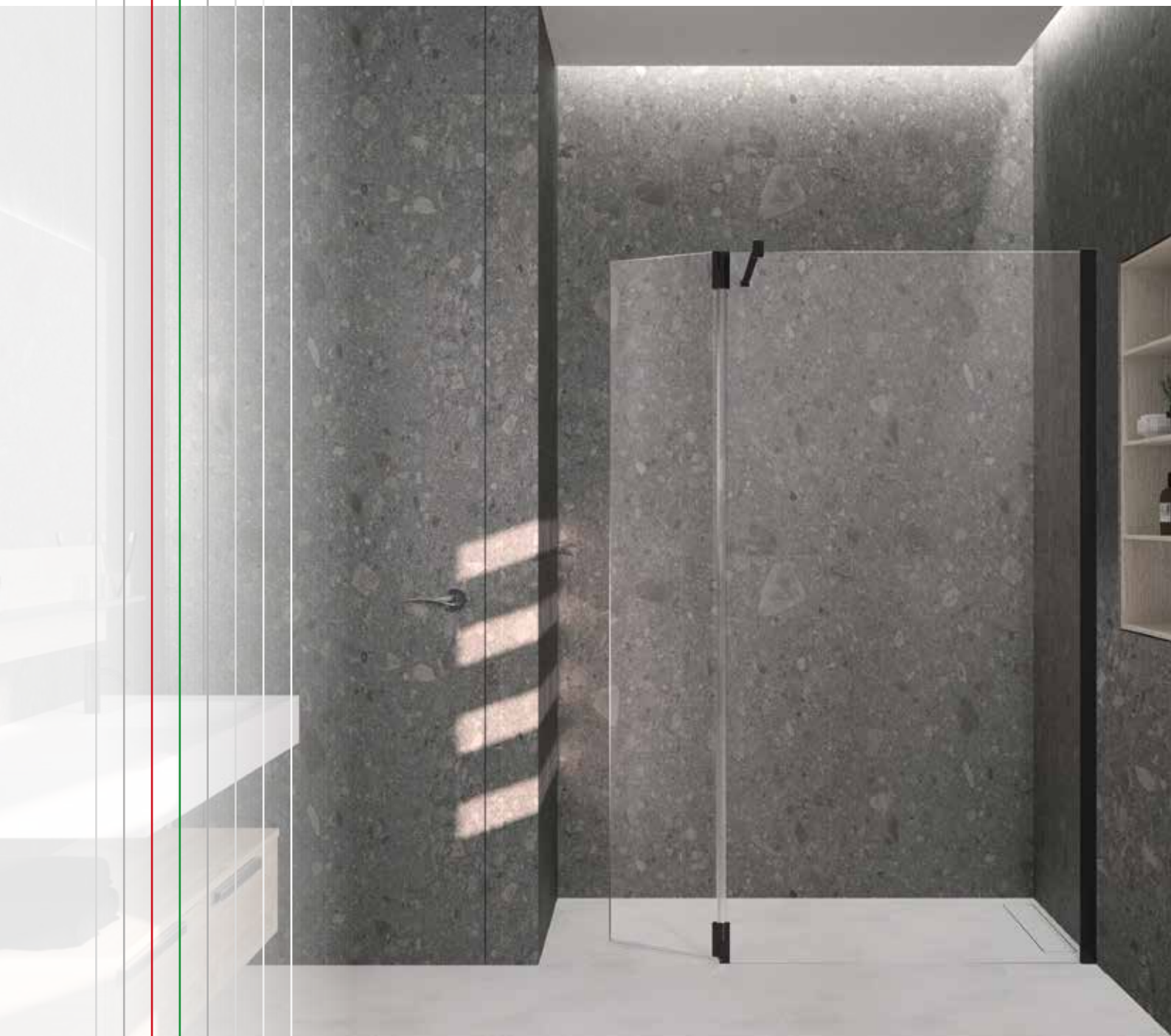



# Contents

<b>Section</b>	<b>Page</b>
Contents	3
What is a Wetroom?	4-5
Choosing your floor style	6-7
Choosing a layout	8-9
<b>Timber floor</b>	
Guidelines	10-11
Mono Deck range	12-15
Duo Deck range	16-17
Quattro Deck range	18-19
Waterproofing	20-21
<b>Concrete floor</b>	
Guidelines	22-23
Drains & Grills	24-26
Linear Graded Board/Trim	27
Waterproofing	28-29
<b>Glass</b>	
How to select	30
Screens - Kuadra	31-33
Enclosures - Young Corner	34-35
Enclosures - Young Alcove	36
Additional products	37
Inspiration	38-39

# What is a Wetroom?

At Novellini we understand that you desire something more individual than just a shower room. That's why we've created a comprehensive wetroom and glass collection that features a range of both stylish and practical solutions for your home.

Our wetrooms offer all the benefits of a walk-in shower, combined with the protection offered by a shower screen or enclosure, allowing you to create a contemporary, luxurious feel to any bathroom.

Using the available space in an efficient and uncluttered manner allows you to create a truly individual showering experience, limited only by your imagination.

## Peace of Mind

Our designers and engineers work with one common goal: to design and manufacture wetroom solutions that are fully integrated. From the hidden technology under the wetroom floor, to our beautifully designed glass screens and enclosures.

## Lifetime Guarantee

All of our wetroom products are covered by the Novellini Product Lifetime Guarantee. Our guarantee is valid only if used with Novellini products and does not cover installation.



## The Complete Package

We offer wetroom solutions for both timber and concrete floors with all systems encompassing the four key components of a wetroom:

- 1 Gradient
- 2 Drainage
- 3 Waterproofing
- 4 Glass



## Key aspects of a Novellini Wetroom

### 1 Gradient

It is important to ensure that the floor of a wetroom has sufficient gradient in order for the water to drain away without forming puddles. Our system offers a choice of pre-formed, engineered slopes guaranteeing a perfect gradient every time.

### 2 Drainage

Whether you desire a contemporary linear drain or a more traditional square outlet you need to be sure that the drain is capable of taking away sufficient water to keep up with the flow from the shower head. Our drains offer the choice of an additional trap, therefore ensuring sufficient drainage is available.

### 3 Waterproofing

It is essential to ensure your wetroom is correctly waterproofed. All of our membranes are easy to apply and are backed up by our Lifetime Guarantee, offering complete peace of mind.

### 4 Glass

Our range of screens and enclosures offer almost unlimited choice, from the simplicity of a single screen right through to our full enclosures and multi-screen options.

# ► Choosing your floor style

## The secret to a successful wetroom

### The Wetroom Deck

Our range of preformed decks have been developed specifically to allow the installation of a wetroom onto a timber floor, which are quick and easy to install. Each Deck has a built-in gradient that flows towards the stylish drain to create a perfect wetroom every time.

Choose from:

Mono Deck - One way fall

Duo Deck - Two way fall

Quattro Deck - Four way fall

For Concrete Floors see pages 22-29

## **Mono Deck** - One way fall for large format tiles



### **Benefits of the Mono Deck**

The Mono Deck is a single slope wetroom system for timber floors, allowing the linear drain to be positioned neatly against the wall. Fewer tile cuts and large tiles ensures a stylish finish.

See p12-15 for details

## **Duo Deck** - Two way fall for large format tiles



### **Benefits of the Duo Deck**

The Duo Deck, with its contemporary linear drain, is perfect for 'large format' tiles, as there are fewer tile cuts required and hence fewer grout lines.

See p16-17 for details

## **Quattro Deck** - Four way fall for mosaic tiles

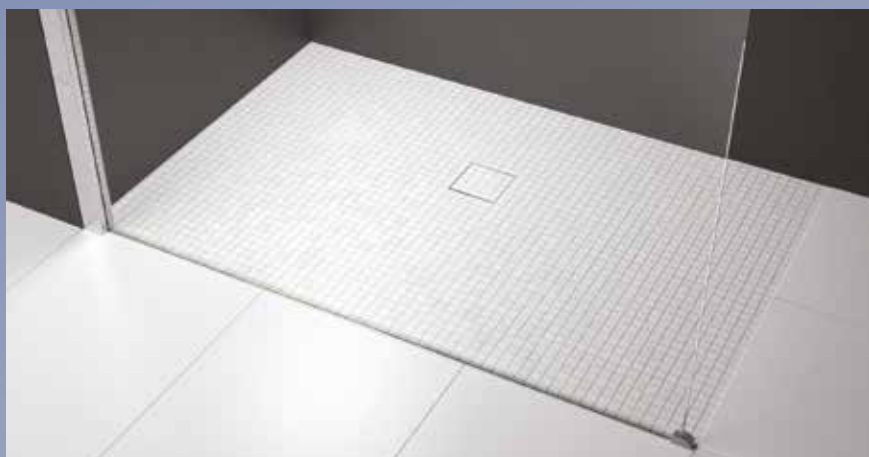

### **Benefits of the Quattro Deck**

The Quattro Deck, with its more traditional square drain, is better suited to smaller 'Mosaic' tiles as the tiles blend more sympathetically into the shape of the Deck.

See p18-19 for details

## ▶ Choosing a layout to suit your room Corner, alcove or wall layout?



### Selecting a layout

The layout of your shower room will determine the glass option required. Typically this will be either a Corner, Alcove or Wall Layout. For the Corner Layout we provide a range of options from the minimalist single panel to the complete enclosure. For the Alcove there is a choice of either a minimal screen with pivot or a single door (with a fixed panel if required). For the Wall Layout we provide a choice of fixed screens with optional side panels.

### How wide should a screen be?

To keep water within shower area A, a minimum of 100cm is acceptable, but 120cm would be preferable. Your glass choice will also be affected by area B which is the amount of aperture you need to enter the shower area. If space is limited, a Kuadra H2 (p27) screen with pivot offers a smaller fixed panel with enhanced shielding.

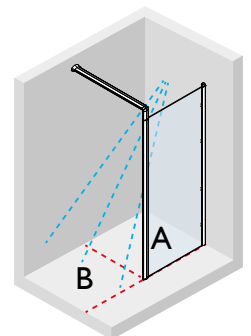



## 1. Corner Layout

For simplicity, select a single glass screen (Kuadra H) but ensure the width of the screen is sufficient to contain the water spray. For more control, choose a screen with a pivot (Kuadra H2) which deflects more water back into the shower area.

Combine screens to form your (Multi-screen) enclosure or choose a Young enclosure to completely contain the water and retain heat within the shower area.

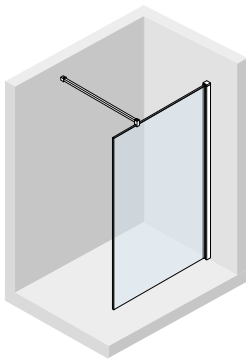

### Single glass

Kuadra H  
See p31

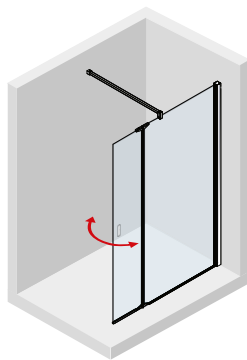

### Screen with pivot

Kuadra H2  
See p31

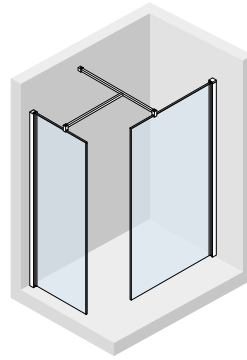

### Multi-screen

Kuadra H with H or H2  
See p31

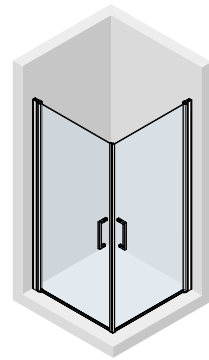

### Enclosure

Young  
See p36

## 2. Alcove Layout

Where your shower area is within an alcove, we provide a minimal screen with pivot (Kuadra H2) or a single door (with fixed panel if required) (Young).

## 3. Wall Layout

Create the feeling of space with a wall layout - perfect for a 'dual' shower. Kuadra Wall features different screen widths along with options for fixed side panels.

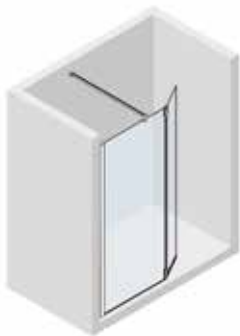

### Screen with pivot

Kuadra H2  
See p31

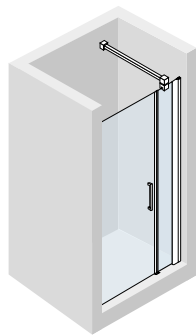

### Single door (+panel)

Young  
See p36

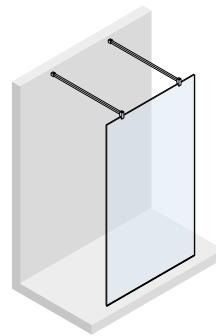

### Single glass

Kuadra Wall  
See Main Catalogue

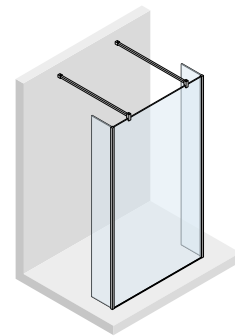

### Single glass with panels

Kuadra Wall  
See Main Catalogue

# Timber Floor - Guidelines

## The Novellini wetroom for Timber Floors

### Introduction

Our range of pre-formed shower Decks has been developed specifically to allow the installation of a level access wetroom on a timber floor.

Available in a range of sizes, the Deck has a pre-formed engineered slope, ensuring that water from the shower

is directed towards the integral drain, guaranteeing a perfect gradient every time.

Novellini Wetroom floor systems can be installed with electric underfloor heating (max specification 150watts/ sq metre).

### Typical timber floor build-up - Duo Deck

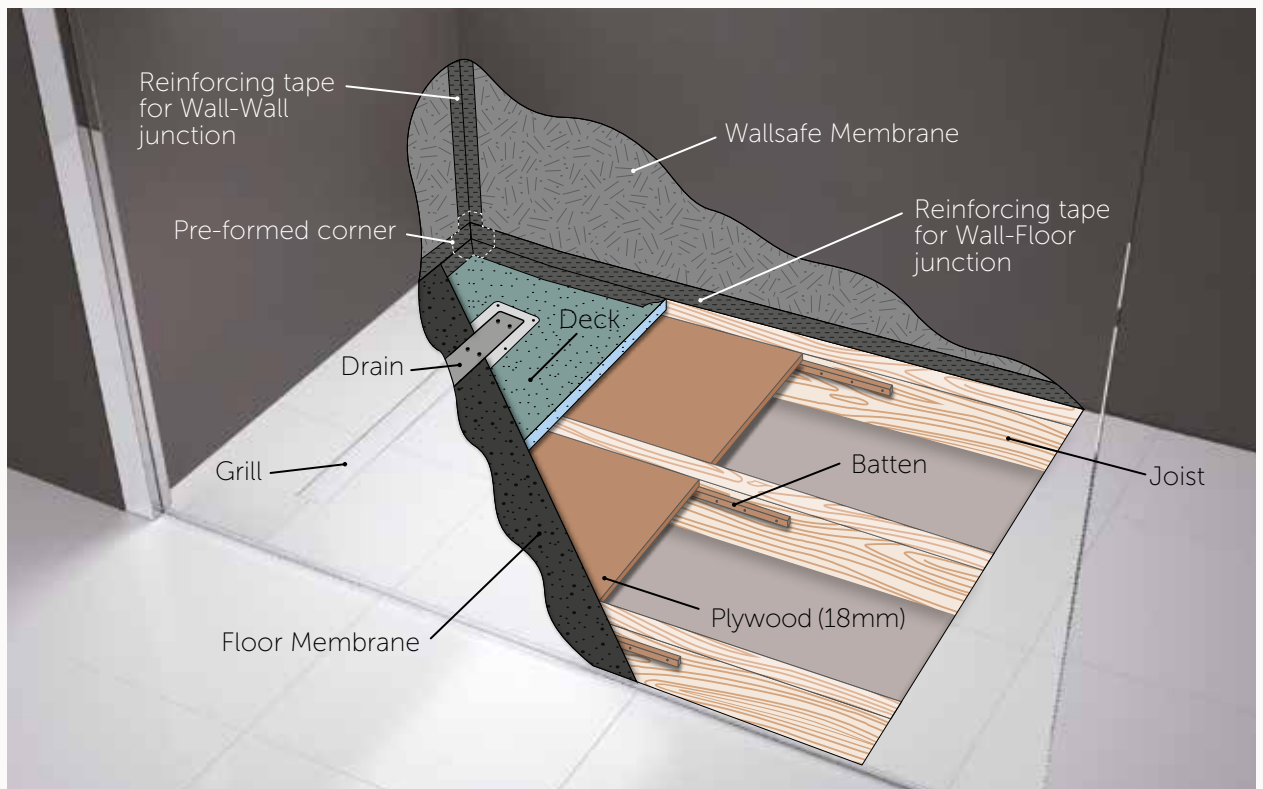

The Drain and Deck are supported by plywood held in place between the floor joists by battens.

The Deck is covered by a self-adhesive waterproof membrane supplied as a Floor Membrane Kit.

The wall is sealed with a waterproof Wall Membrane.

The internal corner of the wetroom is protected using a Pre-formed corner, while the wall-floor horizontal joints and wall-wall vertical joints are sealed with reinforcing tape.

## Three simple steps to order your Timber Floor solution



Flow rate up to  
68 L/min

### Mono Deck

One-way fall with linear drain



Flow rate up to  
41 L/min

### Duo Deck

Two-way fall with linear drain



Flow rate up to  
24 L/min

### Quattro Deck

Four-way fall with square drain

## 1 Deck & Drain

The preformed engineered slope on all Decks guarantees a perfect gradient every time.

Choose either the Mono Deck or Duo Deck for large format tiles, or the Quattro Deck for mosaic tiles.

Each Deck features a multi-directional trap for ease of installation.

For Mono and Duo Decks, additional traps can be added to increase the flow rate.



### Tilesure Floor Membrane Kit



### Floorsafe Floor Membrane Kit

## 2 Floor Membrane Kit

It is essential to ensure your wetroom is correctly waterproofed.

Choose from either a Tilesure or Floorsafe Kit. Both Kits comprise a Floor Membrane, Primer, Pre-formed corners and Reinforcing Tape.



### Wallsafe Wall Membrane



### Wallsafe Reinforcing Tape



### Tilesure Reinforcing Tape



### Floorsafe Reinforcing Tape

## 3 Wall Membrane & Tape

Use Wallsafe to waterproof the walls within and around the shower area.

Use Reinforcing Tape for sealing critical Wall-Wall and Wall-Floor joints.

Ensure the correct Tape is used with the appropriate Floor Membrane Kit.

For full details of waterproofing for timber floors see page 20-21.

\* All of our wetroom products are covered by the Novellini Product Lifetime Guarantee. Our guarantee is valid only if used with Novellini products and does not cover installation.

# Mono Deck - How to Specify

Designed for use with large format tiles, Mono Deck is a 'trimmable on site' wetroom base for timber floors, with a one-way fall towards a linear drain, therefore eliminating the need for diagonal tile cuts.

When choosing the correct kit please take the following into consideration:

- Size of the required shower area
- Position of the drain – on the long wall or short wall
- Number of traps – 1, 2 or 3
- Finish of the linear grill – Stainless Steel, Matt Black or Tile-Infill
- For grill lengths see Mono Kits on p15
- Urgency - bespoke sizes available in 48 hours

For grill lengths see Mono Kits on p15. Simply choose the nearest kit to the required size of the shower area.

**Remember** - The width and length can be trimmed on-site to achieve the required size.

Example below shows Kit 8, trimmed to suit a shower area:

- Drainage Component\*
- Single Horizontal Trap
- Infill Panel\*
- Graded Board\*
- G3 Wall Grill
- Stainless Steel Tile Trim

\* Trimmable on-site

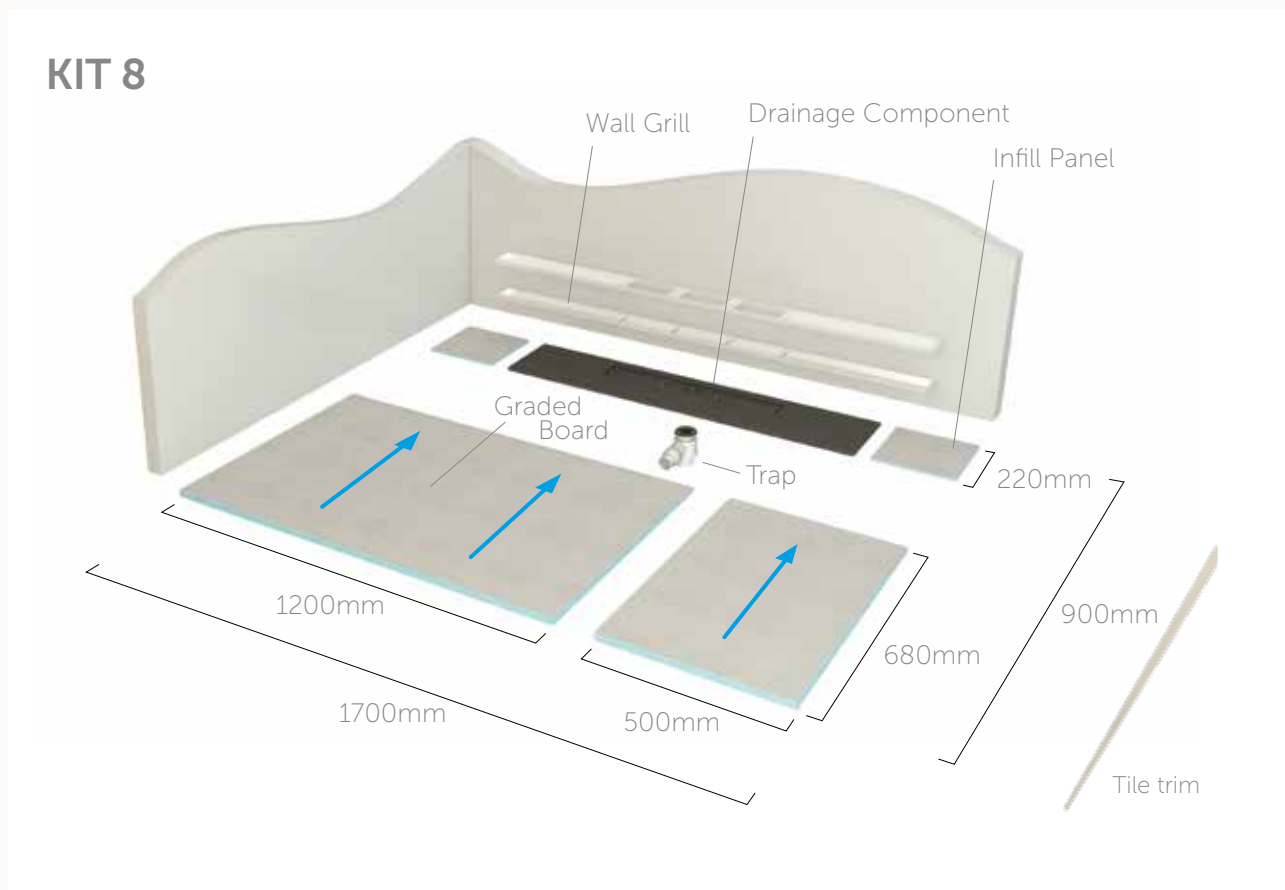

## Drainage Component

The Drainage Component is the central element of the Mono Deck System, once in position, the rest of the system is built around it.



- Width can be trimmed on-site
- Available with 1, 2 or 3 wastes
- Single trap up to 24 L/min
- Double trap up to 41 L/min, Triple to 68L/min
- Height of trap only 130mm
- 360° Rotatable trap with 42mm outlet
- Trap can be positioned off-center to avoid joists
- Single trap supplied as standard, additional traps can be added as required, see page 15.

## Linear Grill

The Mono Deck is supplied with a Linear Grill, which is neatly positioned against the wall, therefore eliminating the need for angled tile cuts. The grill will be supplied up to 300mm shorter than the overall shower. i.e. Kit 8 (see p12) has a maximum size of

1800mm x 1000mm with the drain positioned against the long wall, therefore the grill supplied is 1500mm. Simply choose the G1 or G3 in a stainless steel or matt black finish or add a frameless grill if you have a coloured taps (such as gold) or shower screen frame.

Drain positioned against the long wall.

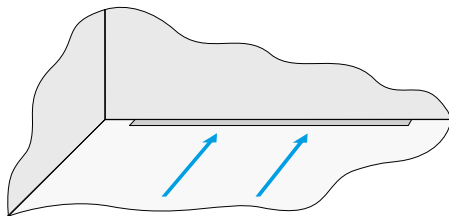

Drain positioned against the short wall.

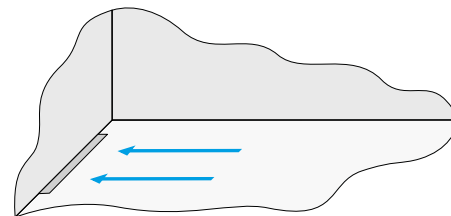

## Graded Board

The Graded Board provides an easy to install one way-fall towards the linear drain. Manufactured from high density XPS, they are trimmable along both dimension A & B, allowing a shower area to be created of almost any size.

- 22mm to 11mm gradient
- Trimmable
- High compressive strength
- Supplied with matching colour tile trim
- Fixing washers included
- Easy to install - no angled tile cuts

## Infill Panel

- 11mm thickness
- Trimmable
- Fixing washers include

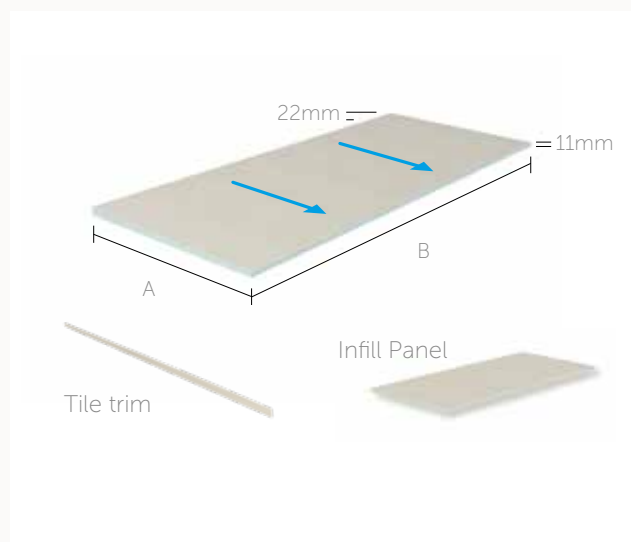

**For full details of waterproofing for timber floors see page 20-21.**

\* All of our wetroom products are covered by the Novellini Product Lifetime Guarantee. Our guarantee is valid only if used with Novellini products and does not cover installation.

# Timber Floor - Mono Deck

## Features of a Mono Deck

The Mono Deck has a single slope one-way fall and can be installed with the linear drain positioned against the long wall or the short wall. The features of a Mono Deck are summarised below:

- Single slope one-way fall
- Create a shower area almost any size
- Easy to install
- Easy to tile using large format tiles
- Linear grills in various lengths & finishes
- Easy grill removal for cleaning
- Bespoke grills available
- Lifetime Guarantee

## Drain position

Positioning the drain against the wall provides a one-way gradient within the shower, ensuring the user is not standing on the drain. This also omits the need for diagonal tile cuts, giving a more stylish look which is both easier to install and maintain.

### Drain against Short Wall

#### Corner layout

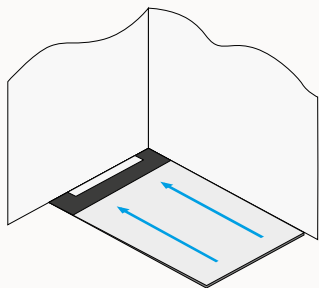

### Drain against Long Wall

#### 1. Corner layout

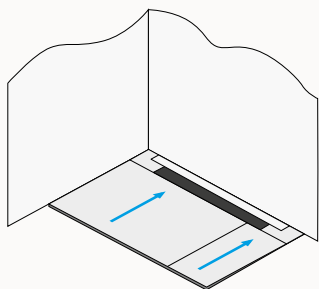

#### 2. Alcove layout

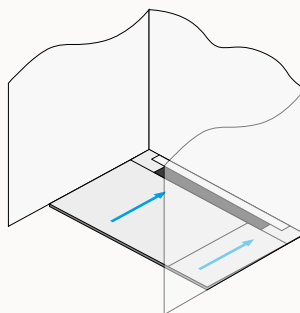

#### 3. Wall layout

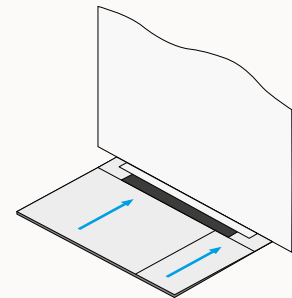

**1** Select your **Mono Kit** and **Grill**. Add additional trap if required.



**Mono Kits** (for complete product code add kit code to grill code: MONOKIT**G1**)

SHORT WALL LAYOUT*	DIMENSION** A	DIMENSION** B	GRILL LENGTH	KIT CODE	GRILL <b>G1</b> £ inc VAT	GRILL <b>G3</b> £ inc VAT	GRILL <b>G1H</b> £ inc VAT	GRILL <b>G3H</b> £ inc VAT
	1000mm	800 - 1000mm	700mm	MONOKIT1..	806.45	884.04	996.54	1067.33
	1200mm			MONOKIT2..	859.88	936.2	1037.24	1108.03
	1400mm			MONOKIT3..	886.59	964.18	1077.94	1148.72
	1700mm			MONOKIT4..	964.18	1040.5	1179.46	1250.24

LONG WALL LAYOUT*	DIMENSION** B	DIMENSION** A	GRILL LENGTH	KIT CODE	GRILL <b>G1</b> £ inc VAT	GRILL <b>G3</b> £ inc VAT	GRILL <b>G1H</b> £ inc VAT	GRILL <b>G3H</b> £ inc VAT
	1200mm	800 - 1000mm	900mm	MONOKIT5..	862.42	937.47	996.54	1067.33
	1400mm		1100mm	MONOKIT6..	1079.93	1156.25	1238.66	1309.87
	1600mm		1300mm	MONOKIT7..	1121.91	1198.23	1276.1	1347.28
	1800mm		1500mm	MONOKIT8..	1162.61	1240.20	1314.82	1385.98

**NB - Optional frameless grill available on request for use with gold/brushed brass finishes.**

- \* See page 14 (opposite) for details of Long and Short Wall Layouts
- \*\* Dimensions A&B can be cut down to suit your shower space. Other board and drain sizes are available upon request.

**Grill options**

Item: S/Steel Solid Grill  
Code: **G1**



Item: S/Steel Tile Infill Grill  
Code: **G3**



Item: Black Solid Grill  
Code: **G1H**



Item: Black Tile Infill Grill  
Code: **G3H**



**Additional traps (if required)**



Item: Duo Extra\*  
Code: DUOWA90  
£ (inc VAT): 67.42

\*(horizontal fast-flo trap)



Item: Duo Optional\*  
Code: DUOVT90  
£ (inc VAT): 67.42

\*(vertical fast-flo trap)

**For full details of waterproofing for timber floors see page 20-21.**

\* All of our wetroom products are covered by the Novellini Product Lifetime Guarantee. Our guarantee is valid only if used with Novellini products and does not cover installation.

# Timber Floor - Duo Deck

## Duo Deck (with Two-way fall)

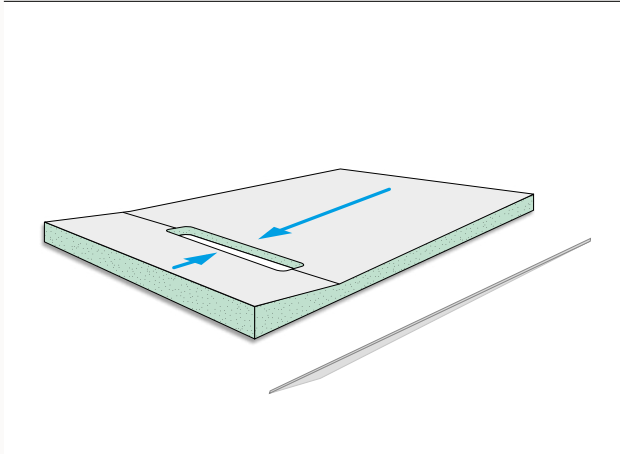

The Duo Deck - 2 way fall

### Features of a Duo Deck

- Two-way fall suited to large format tiles
- Designed for timber floors
- Lifetime Guarantee
- 22mm depth
- 9 Pre-formed sizes
- Flow rate up to 41 L/min (with two traps)
- Easily trimmed (up to 50mm from any side)
- Supplied with stainless steel Tile Trim

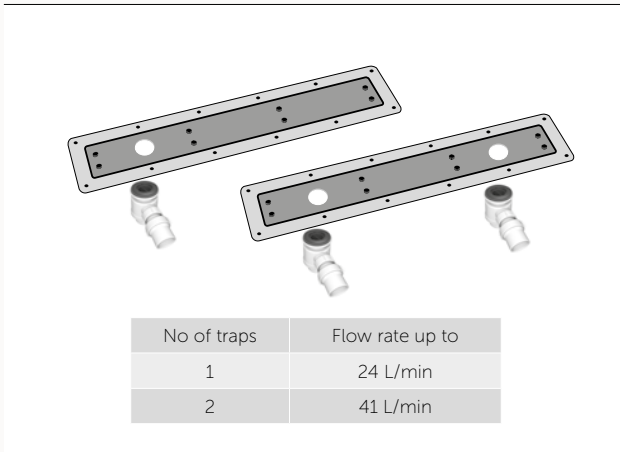

Drain and trap

### Features of the drain and trap

- Contemporary linear drain
- Waste position can be varied on-site to avoid joists
- Available with two wastes
- Flow rate up to 41 L/min (with two traps)
- 360° Rotatable trap with 42mm outlet
- Height adjustable grill
- Height of trap only 130mm

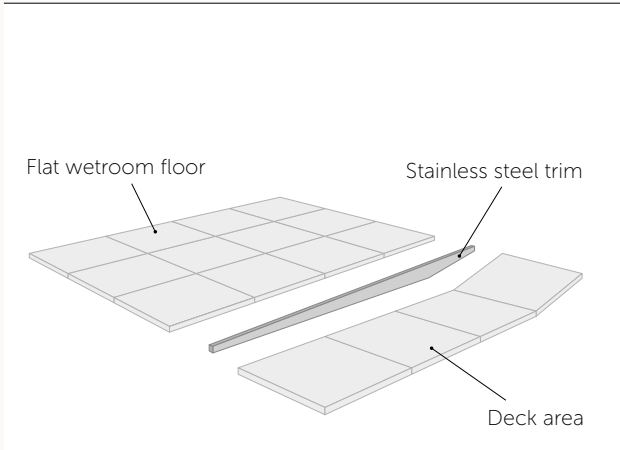

Trim detail

### Trim detail

Supplied with the Deck, the trim provides a stylish stainless steel finish detailing for the difference in tile heights where the Deck meets the remainder of the wetroom floor.



**1** Select your **Duo Kit** and **Grill**. Add additional trap if required.



### Duo Kits

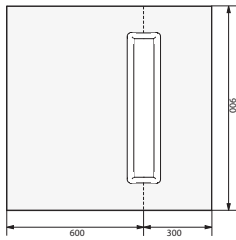

Size:	900 x 900mm
Code:	DUOKIT1G1 ...G3
£ (Inc VAT):	727.59 802.64

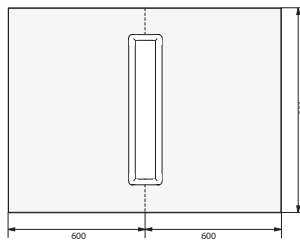

Size:	1200 x 900mm C
Code:	DUOKIT2G1 ...G3
£ (Inc VAT):	881.50 956.55

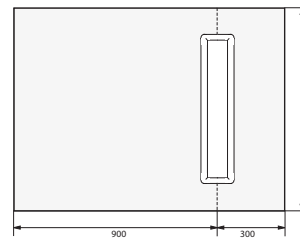

Size:	1200 x 900mm E
Code:	DUOKIT3G1 ...G3
£ (Inc VAT):	881.50 956.55

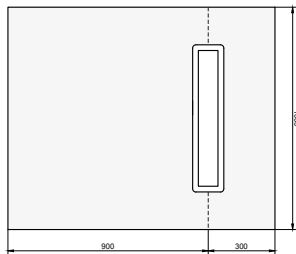

Size:	1200 x 1000mm
Code:	DUOKIT8G1 ...G3
£ (Inc VAT):	881.50 956.55

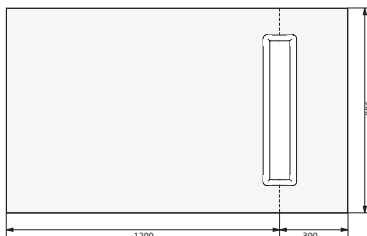

Size:	1500 x 900mm
Code:	DUOKIT4G1 ...G3
£ (Inc VAT):	1016.33 1091.38

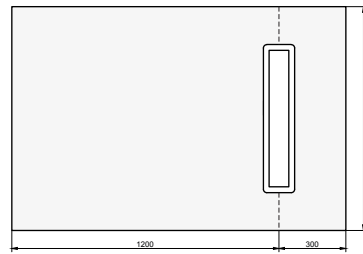

Size:	1500 x 1000mm
Code:	DUOKIT9G1 ...G3
£ (Inc VAT):	1016.33 1091.38



Size:	1800 x 900mm
Code:	DUOKIT5G1 ...G3
£ (Inc VAT):	1067.21 1143.53

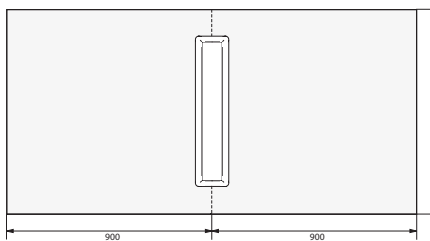

Size:	1800 x 900mm C
Code:	DUOKIT6G1 ...G3
£ (Inc VAT):	1067.21 1143.53

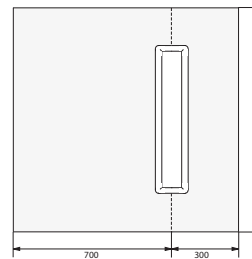

Size:	1000 x 1000mm
Code:	DUOKIT7G1 ...G3
£ (Inc VAT):	881.50 956.55

### Grill options - Black and Frameless grill options available on request.



Item:	Solid Grill
Code:	G1



Item:	Tile Infill Grill
Code:	G3

**NB Kits with code G1 include a Solid Grill. Kits with code G3 include Tile Infill Grill.**

### Additional traps (if required - see flow rate table opposite)



Item:	Duo Extra*
Code:	DUOWA90
£ (Inc VAT):	67.42

\*(horizontal fast-flt trap)



Item:	Duo Optional*
Code:	DUOVT90
£ (Inc VAT):	67.42

\*(vertical fast-flt trap)

For full details of waterproofing for timber floors see page 20-21.

\* All of our wetroom products are covered by the Novellini Product Lifetime Guarantee. Our guarantee is valid only if used with Novellini products and does not cover installation.

# Timber Floor - Quattro Deck

**Quattro Deck** (with Four-way fall)

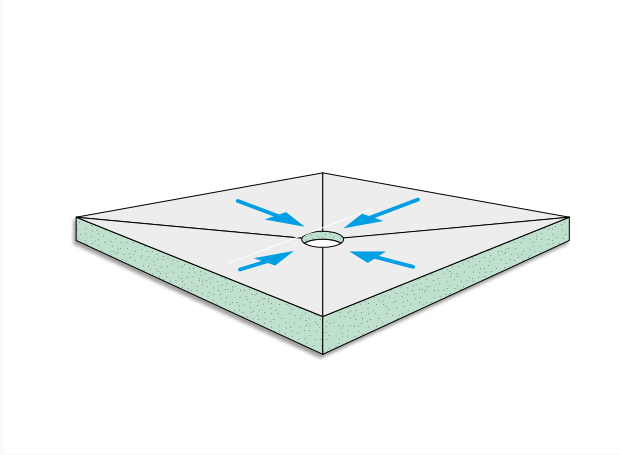

Quattro Deck

## Features of a Quattro Deck

- Four-way fall suited to mosaic tiles
- Designed for timber floors
- Lifetime Guarantee
- 22mm depth
- 8 Pre-formed sizes
- Easily trimmed (up to 50mm from any side)

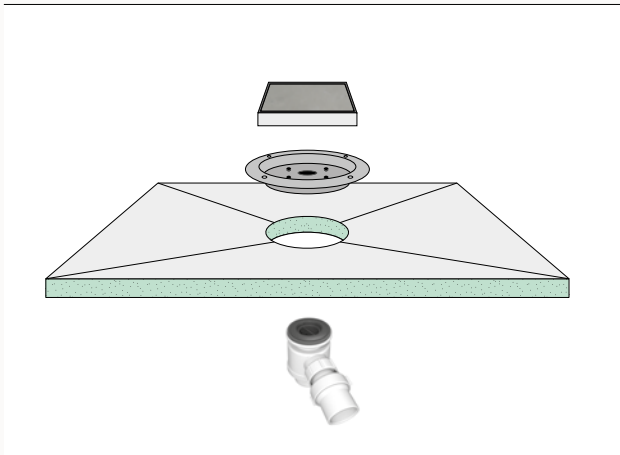

Quattro Grill, Trap and Drain

## Features of the drain and trap

- Traditional square drain
- Flow rate up to 24 L/min
- 360° Rotatable trap with 42mm outlet
- Height adjustable grill

# 1 Select your Quattro Kit and Grill option



## Quattro Kits

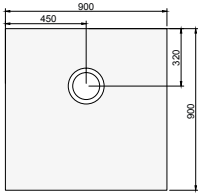

Size:	900 x 900mm
Code:	QKIT1G1 ...G3
£ (Inc VAT):	548.24 588.94

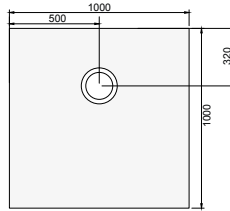

Size:	1000 x 1000mm
Code:	QKIT2G1 ...G3
£ (Inc VAT):	563.5 604.2

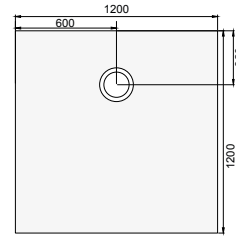

Size:	1200 x 1200mm
Code:	QKIT3G1 ...G3
£ (Inc VAT):	714.87 755.57

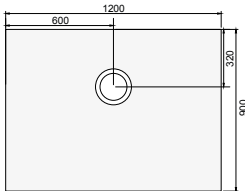

Size:	1200 x 900mm
Code:	QKIT4G1 ...G3
£ (Inc VAT):	597.84 638.55

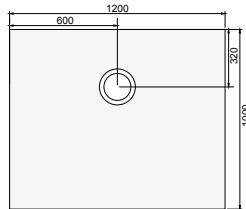

Size:	1200 x 1000mm
Code:	QKIT5G1 ...G3
£ (Inc VAT):	630.92 671.62

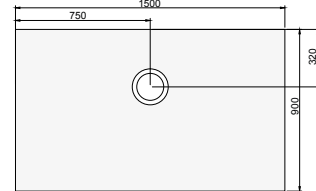

Size:	1500 x 900mm
Code:	QKIT6G1 ...G3
£ (Inc VAT):	630.92 671.62

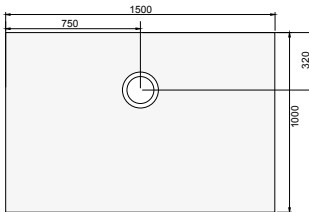

Size:	1500 x 1000mm
Code:	QKIT7G1 ...G3
£ (Inc VAT):	662.72 704.69

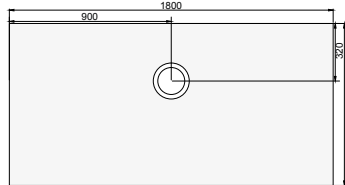

Size:	1800 x 900mm
Code:	QKIT8G1 ...G3
£ (Inc VAT):	830.62 872.6

## Grill options - Black and Frameless grill options available on request.



Item:	Solid Grill
Code:	G1



Item:	Tile Infill Grill
Code:	G3

**NB Kits with code G1 include a Solid Grill. Kits with code G3 include Tile Infill Grill.**

For full details of waterproofing for timber floors see page 20-21.

\* All of our wetroom products are covered by the Novellini Product Lifetime Guarantee. Our guarantee is valid only if used with Novellini products and does not cover installation.

# Timber Floor - Waterproofing

## A guide to Waterproofing your wetroom

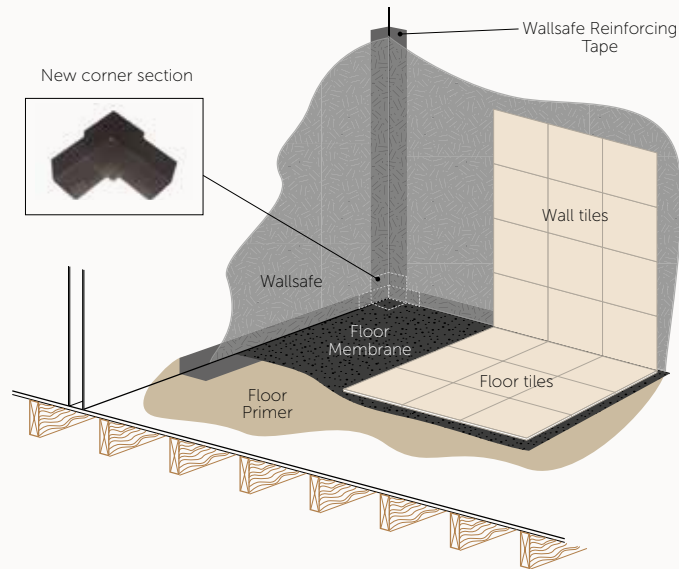

### The importance of Waterproofing

The primary concern for anyone choosing to create a Wetroom is whether the floor or walls will either absorb, or worse let water through. Through our painstaking research and development we have created a system that is guaranteed, not just for a few years, but for life. The two components of this system are firstly the floor membrane and secondly the wall membrane, which are the key products for waterproofing the wetroom floor and walls.

We offer two self adhesive waterproof solutions for the floor membrane designed for use prior to the application of ceramic tiles and natural stone onto timber and solid floors in wetrooms:

- **Tilesure** is an evolution of our popular Tilesafe membrane which has been the professional's choice for over 15 years in both the commercial and domestic sectors. Developed specifically for use in bathrooms and wetrooms, Tilesure is comprised of a 1.4mm butyl based membrane with a copolymer top layer, which provides an excellent surface for the adhesion of natural stone, porcelain and ceramic tiles. Tilesure is quick and easy to apply, providing a consistent waterproof layer, guaranteed not to leak.

Tilesure also acts as a decoupling membrane by uncoupling the floor tiles and accommodating movement in the substrate, within a thickness of only 1.4mm. This omits the requirement for a traditional decoupling mat.

- **Floorsafe** – developed as a light weight, easy-fit, domestic product, is a cold-applied self-adhesive membrane which consists of a thin rubberised butyl waterproof layer with a fleece top surface.

For walls we recommend **Wallsafe**:

- A flexible single application paint-on waterproofing membrane, applied to the wall surfaces prior to the application of ceramic tiles and/or natural stone in wetrooms.

### Application

For timber floors we recommend that either floor membrane, Tilesure or Floorsafe, is applied to the entire wetroom floor or at least to a distance of no less than 1 metre from the shower area. Wallsafe should then be applied to the walls of the shower area and overlapped onto the Reinforcing Tape.

2

## Select Membrane Kit

### Floor Membrane Kits



#### Tilesure 5m² Kit

500ml Primer, 10m Reinforcing Tape 5m x 1m Membrane 290ml Jointing Compound 4 x Pre-formed Corners

#### Floorsafe 5m² Kit

500ml Primer, 10m Reinforcing Tape 5m x 1m Membrane 290ml Jointing Compound 4 x Pre-formed Corners

#### Tilesure 10m² Kit

1ltr Primer, 15m Reinforcing Tape 10m x 1m Membrane 290ml Jointing Compound 4 x Pre-formed Corners

#### Floorsafe 10m² Kit

1ltr Primer, 15m Reinforcing tape 10m x 1m Membrane 290ml Jointing Compound 4 x Pre-formed Corners

Tilesure and Floorsafe are compatible with electric underfloor heating up to 150kw per m².



Choose from either Tilesure or Floorsafe kits:

**Tilesure Kit** offers the following features:

- Suitable for timber and solid floors
- Decouples up to 12mm
- Compatible with silicone sealants
- Self-adhesive - quick and easy to apply
- Ready to tile immediately

**Floorsafe Kit** offers the following features:

- Suitable for timber and solid floors
- Self-adhesive - quick and easy to apply
- Ready to tile immediately

ITEM	CODE	£ INC VAT
Tilesure 5m Kit	TSURE5	449.02
Tilesure 10m Kit	TSURE10	619.47
Floorsafe 5m Kit	BTMK5	382.88
Floorsafe 10m Kit	BTMK10	508.8

### Additional Reinforcing Tape



**Tilesure Reinforcing Tape**  
10m roll



**Floorsafe Reinforcing Tape**  
10m roll

A self-adhesive reinforcing tape for use with the floor membrane. Choose either Tilesure or Floorsafe Tape, according to the Floor Membrane Kit selected. Reinforcing Tape is 125mm wide and suitable for all commonly encountered substrates.



ITEM	CODE	£ INC VAT
Tilesure Tape 10m	TAPEU10	99.22
Floorsafe Tape 10m	BTMTAPE10	75.05

### Wall Membrane



**Wallsafe Membrane**



**Wallsafe Reinforcing Tape**

#### Wallsafe Membrane

- Quick and easy single coat application
- Compatible with Tilesure and Floorsafe
- Solvent free - covers up to 8m²
- Suitable for all commonly encountered substrates

#### Wallsafe Reinforcing Tape

- 75mm Wide x 10m
- Self-adhesive
- For use in corner wall junctions, vertical joints, soap recesses and other such detail

ITEM	CODE	£ INC VAT
Wallsafe Liquid 8kg	WSAFE8	124.66
Wallsafe Tape 75mm	WSAFET10	59.79



# Concrete Floor - Guidelines

## The Novellini wetroom for solid floors



### Floor build-up

Our range of linear drains has been developed specifically for concrete or screeded floors and can be used on concrete slabs, planks and block and beam floors.

The key feature of the Linear Floor Drain is its height - the total height from the base to the top of the trough being **only 55mm** (see image below), making it perfect for today's modern construction methods.

The drain incorporates a unique 'waterless trap' which has a lifetime guarantee and has been granted BBA approval. For details see below.

Novellini Wetroom floor systems are suitable to be installed in combination with electric underfloor heating (max specification 150 watts/sq metre).

### Typical solid floor build-up

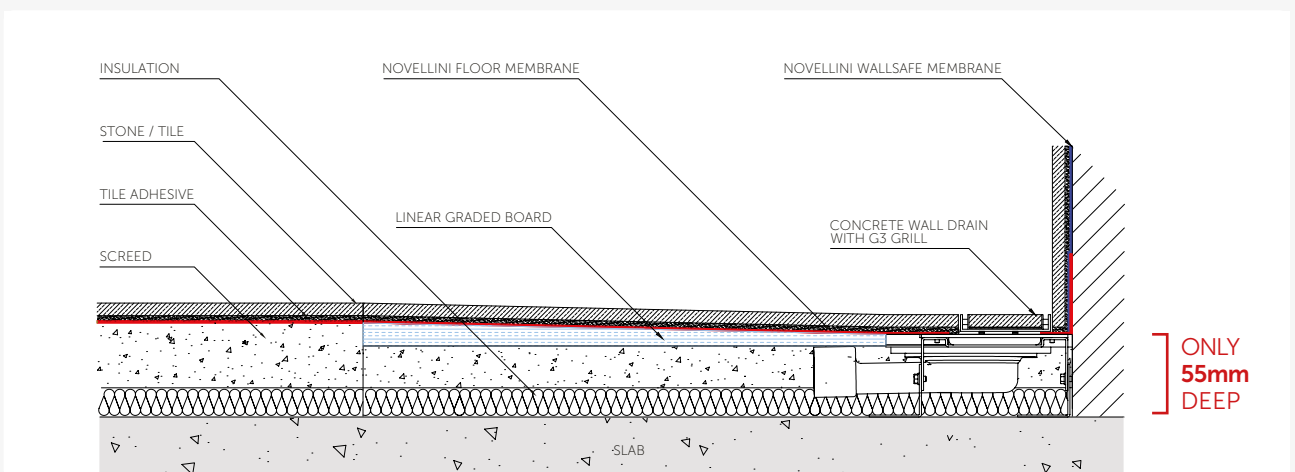

### Waterless Trap

All drains are available with one or two traps and a choice of stylish grill finishes. The trap has been specially designed with a spring loaded mechanism which keeps the trap sealed when not in use. This ensures that even when left

unused for prolonged periods the trap cannot dry out, making it ideal for situations where the shower is not in everyday use. The smart design of the linear trough allows the waste position to be rotated through 360° enabling installation in most scenarios with ease.

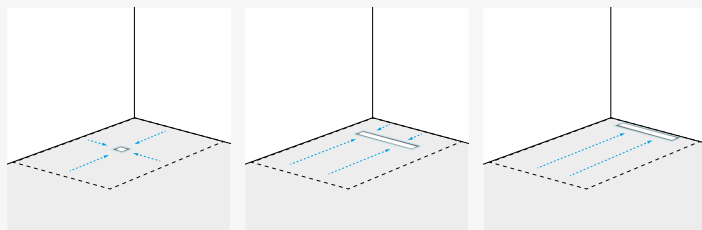

## Four simple steps to order your Concrete Floor solution

**Uno4 Drain**
**Linear Floor Drain**
**Linear Wall Drain**

Flow rate up to  
24 L/min



Flow rate up to  
56 L/min



Flow rate up to  
56 L/min

### 1 Drain and Grill

The gradient is formed within the screed, typically 12mm from the finished floor level to the drain.

All drains feature a multi-directional outlet for ease of installation.

Linear Drains are available with either Single or Double outlet depending on the flow rate required. Linear Drains are available in several lengths - see page 21 for details.

Choose either:

- Uno4 Drain - for a four-way fall
- Linear Floor Drain - for a two-way fall or
- Linear Wall Drain - for a one-way fall



### 2 Graded Board and Tile Trim

Use the Graded Board to provide a pre-formed consistent gradient towards the drain. For all Linear Drains it is important to order a trim detail to define the edge of the wetroom area.



**Screedsure**  
Concrete Floor Membrane Kit

### 3 Floor Membrane Kit

It is essential to ensure your concrete floor wetroom is correctly waterproofed using a Screedsure Floor Membrane Kit.



**Wallsafe Membrane**



**Wallsafe Reinforcing Tape**



**Additional Reinforcing Tape**  
Screedsure Reinforcing Tape

### 4 Wall Membrane & Reinforcing Tape

Use Wallsafe on the walls within and around the shower area. Use Reinforcing tape for sealing critical Wall-Wall and Wall-Floor joints.

For full details of waterproofing for concrete floors see page 28.

# Concrete Floor - Drain & Grill



Uno4 Drain - 4 way fall

## Features of the Uno4 Drain

- Height adjustable drain body
- 360° Rotatable waste position
- Horizontal (height 138-255mm) & Vertical (height 55-88mm) trap options
- Flow rate up to 24 L/min
- Height adjustable grill
- Grill size 130mm x 130mm
- Lifetime Homes compatible

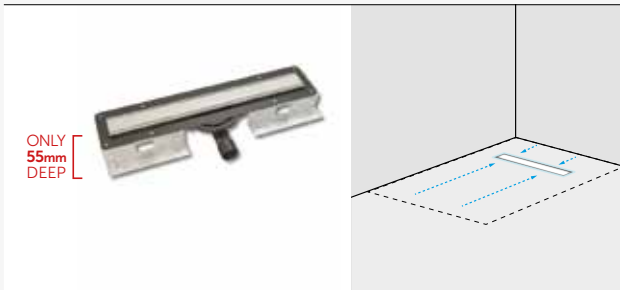

Linear Floor Drain - 2 way fall

## Features of a Linear Floor Drain

- Height adjustable 55-88mm with height adjustable grill
- BBA approved
- Lifetime Guarantee
- 360° rotatable waste position
- Waterless trap with flow rate up to 50 L/min
- Ideal for creating two or more fall gradient
- Easy to clean and replace trap
- Bespoke design available
- Choice of grill finishes colour options
- Grill width 58mm, grill lengths from 600 - 2000mm

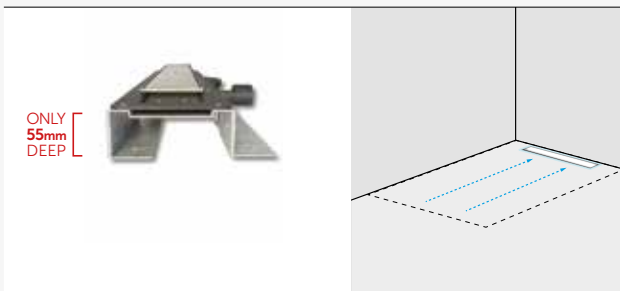

Linear Wall Drain - 1 way fall

## Features of a Linear Wall Drain

- Height adjustable 55-88mm with height adjustable grill
- BBA approved
- Lifetime Guarantee
- 360° rotatable waste position
- Waterless trap with flow rate up to 50 L/min
- Ideal for creating a single fall wetroom
- Easy to clean and replace trap
- Bespoke design available
- Choice of grill finishes colour options
- Grill width 58mm, grill lengths from 600 - 2000mm
- Drain sits against the wall tile, away from your feet



## Features of the Drain and Trap

- BBA approved
- 360° rotatable waste position
- Easy to clean and replace trap
- No requirement to top up the trap during long periods of non-use
- No siphoning of the trap due to other appliances
- No chance of smells or gases entering the room
- Available with one or two traps



**1**
**Select Drain and Grill (see p26 for Linear Wall Drains)**

## Uno4 Drain

For complete product code add base code to grill code: UNO4HT**G3H**  
HT = Horizontal Trap, VT = Vertical Trap



DESCRIPTION	GRILL SIZE	BASE CODE	GRILL <b>G1</b> £ inc VAT	GRILL <b>G3</b> £ inc VAT	GRILL <b>G1H</b> £ inc VAT	GRILL <b>G3H</b> £ inc VAT
Single trap Uno4 Screed Drain, supplied with solid grill as standard. Maximum flow rate 24 L/min.	130 x 130mm	UNO4HT..	328.18	405.77	476.83	562.46
	130 x 130mm	UNO4VT..	328.18	405.77	476.83	562.46



## Grill options

Item: S/Steel Solid Grill  
Code: **G1**



Item: S/Steel Tile Infill Grill  
Code: **G3**

NB Tile not supplied



Item: Black Solid Grill  
Code: **G1H**



Item: Black Tile Infill Grill  
Code: **G3H**

NB Tile not supplied



## Linear Floor Drain

For complete product code add base code to grill code: CD120**G3H**  
Bespoke lengths from 600-2000mm available on request. Please allow 7 days for delivery.



DESCRIPTION	GRILL LENGTH	BASE CODE	GRILL <b>G1</b> £ inc VAT	GRILL <b>G3</b> £ inc VAT	GRILL <b>G1H</b> £ inc VAT	GRILL <b>G3H</b> £ inc VAT
Single trap Linear Floor Drain, supplied with solid grill as standard. Maximum flow rate 29 L/min.	600 mm	CD60..	485.91	562.23	651.02	738.66
	700 mm	CD70..	498.63	577.49	721.53	809.17
	800 mm	CD80..	536.79	613.11	721.53	809.17
	900 mm	CD90..	545.69	622.01	721.53	809.17
	1000 mm	CD100..	587.67	662.72	808.92	896.41
	1100 mm	CD110..	609.29	684.34	844.35	931.95
	1200 mm	CD120..	627.10	704.69	808.92	896.41
	1300 mm	CD130..	639.82	716.14	844.35	931.95
	1400 mm	CD140..	655.08	731.40	886.99	974.48
	1500 mm	CD150..	671.62	746.67	886.99	974.48
	1600 mm	CD160..	697.70	760.54	967.02	1042.42
	1700 mm	CD170..	697.70	760.54	967.02	1042.42
	1800 mm	CD180..	731.18	796.99	1007.19	1086.17
	1900 mm	CD190..	731.18	796.99	1007.19	1086.17
2000 mm	CD200..	766.25	835.21	1049.28	1132.03	

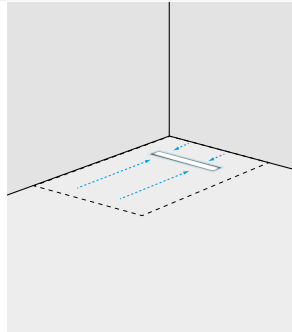

DESCRIPTION	GRILL LENGTH	BASE CODE	GRILL <b>G1</b> £ inc VAT	GRILL <b>G3</b> £ inc VAT	GRILL <b>G1H</b> £ inc VAT	GRILL <b>G3H</b> £ inc VAT
Double trap Linear Floor Drain, supplied with solid grill as standard. Maximum flow rate 56 L/min.	600 mm	CDDT60..	601.66	676.71	779.49	867.03
	700 mm	CDDT70..	620.74	698.33	851.31	938.85
	800 mm	CDDT80..	651.27	728.86	851.31	938.85
	900 mm	CDDT90..	662.72	739.04	851.31	938.85
	1000 mm	CDDT100..	702.15	777.20	938.55	1026.09
	1100 mm	CDDT110..	709.78	787.37	938.55	1026.09
	1200 mm	CDDT120..	733.95	811.54	974.13	1061.68
	1300 mm	CDDT130..	740.31	816.63	974.13	1061.63
	1400 mm	CDDT140..	756.84	833.16	1012.59	1100.18
	1500 mm	CDDT150..	770.84	848.43	1012.59	1100.18
	1600 mm	CDDT160..	797.83	869.65	1087.18	1173.36
	1700 mm	CDDT170..	797.83	869.65	1087.18	1173.36
	1800 mm	CDDT180..	829.75	904.43	1125.48	1215.09
	1900 mm	CDDT190..	829.75	904.43	1125.48	1215.09
2000 mm	CDDT200..	862.90	940.60	1165.25	1258.49	

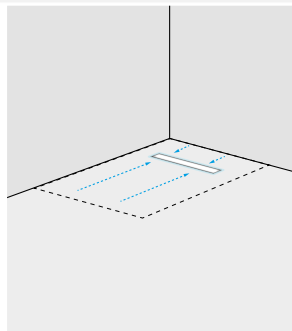

For full details of waterproofing for concrete floors see page 28.

\* All of our wetroom products are covered by the Novellini Product Lifetime Guarantee. Our guarantee is valid only if used with Novellini products and does not cover installation.

1

Select Drain and Grill



Linear Wall Drain

For complete product code add base code to grill code: CWD120**G3H**  
 Bespoke lengths from 600-2000mm available on request. Please allow 7 days for delivery.

DESCRIPTION	GRILL LENGTH	BASE CODE	GRILL <b>G1</b> £ inc VAT	GRILL <b>G3</b> £ inc VAT	GRILL <b>G1H</b> £ inc VAT	GRILL <b>G3H</b> £ inc VAT
Single trap Linear Wall Drain, supplied with solid grill as standard. Maximum flow rate 29 L/min	600 mm	CWD60..	544.42	620.74	760.79	848.43
	700 mm	CWD70..	563.50	641.09	832.15	919.75
	800 mm	CWD80..	595.30	671.62	832.15	919.75
	900 mm	CWD90..	623.28	699.60	832.15	919.75
	1000 mm	CWD100..	644.91	721.23	910.53	998.07
	1100 mm	CWD110..	671.62	746.67	910.53	998.07
	1200 mm	CWD120..	711.05	788.64	949.38	1036.98
	1300 mm	CWD130..	740.31	816.63	949.38	1036.93
	1400 mm	CWD140..	756.84	833.16	990.51	1078.01
	1500 mm	CWD150..	770.84	848.43	990.51	1078.01
	1600 mm	CWD160..	789.98	861.08	1077.75	1163.08
	1700 mm	CWD170..	789.98	861.08	1077.75	1163.08
	1800 mm	CWD180..	827.90	902.46	1123.26	1212.72
1900 mm	CWD190..	827.90	902.46	1123.26	1212.72	
2000 mm	CWD200..	867.64	945.72	1170.94	1264.64	

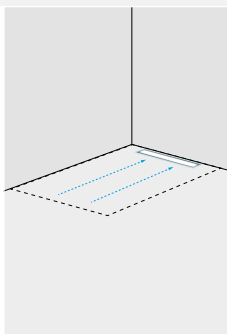

DESCRIPTION	GRILL LENGTH	BASE CODE	GRILL <b>G1</b> £ inc VAT	GRILL <b>G3</b> £ inc VAT	GRILL <b>G1H</b> £ inc VAT	GRILL <b>G3H</b> £ inc VAT
Double trap Linear Wall Drain, supplied with solid grill as standard. Maximum flow rate 56 L/min	600 mm	CWDDT60..	651.27	728.86	890.57	978.11
	700 mm	CWDDT70..	670.35	747.94	961.88	1049.38
	800 mm	CWDDT80..	702.15	777.20	961.88	1049.38
	900 mm	CWDDT90..	717.41	793.73	961.88	1049.38
	1000 mm	CWDDT100..	751.76	826.80	1040.26	1127.75
	1100 mm	CWDDT110..	778.47	854.79	1040.26	1166.71
	1200 mm	CWDDT120..	800.09	876.41	1079.11	1127.75
	1300 mm	CWDDT130..	811.54	886.59	1079.11	1166.71
	1400 mm	CWDDT140..	826.80	904.40	1120.39	1207.89
	1500 mm	CWDDT150..	842.07	918.39	1120.39	1207.89
	1600 mm	CWDDT160..	897.29	962.14	1206.53	1284.34
	1700 mm	CWDDT170..	897.29	962.14	1206.53	1284.34
	1800 mm	CWDDT180..	933.20	1007.83	1249.62	1339.18
1900 mm	CWDDT190..	933.20	1007.83	1249.62	1339.18	
2000 mm	CWDDT200..	965.80	1034.63	1288.73	1371.33	

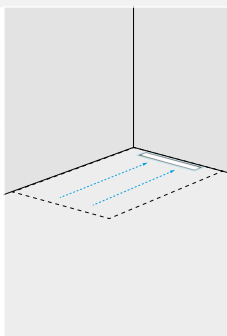

Grill options

Item: S/Steel Solid Grill  
Code: **G1**



Item: S/Steel Tile Infill Grill  
Code: **G3**



Item: Black Solid Grill  
Code: **G1H**



Item: Black Tile Infill Grill  
Code: **G3H**



## 2 Select Linear Graded Board and Trim



### Linear Graded Board

Tile Strip:

These boards reduce installation time and guarantee the perfect gradient by using the slope of the board rather than screed to create the fall.

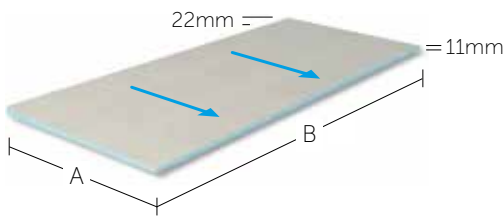

ITEM	CODE	DIMENSIONS (mm)		£ INC VAT
		A	B	
Board 1	LINGB300	300	1200	123.39
Board 2	LINGB500	500	1200	174.27
Board 3	LINGB700	700	1200	227.69
Board 4	LINGB800	800	1200	244.23
Board 5	LINGB900	900	1200	263.31
Board 6	LINGB1000	1000	1200	284.93
Board 7	LINGB1100	1100	1200	296.38
Board 8	LINGB1200	1200	1200	312.92
Board 9*	LINGB1500	1500	1200	389.24

\*Supplied in two pieces

### Infill Panel

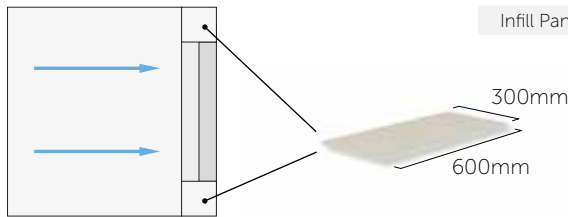

Infill Panel	LINIP1	300	600	27.99
--------------	--------	-----	-----	-------

Infill Panels are used for configurations where the width of the Linear Graded Board exceeds the width of the drain. Infill panels come in a standard 300 x 600mm format, but can be trimmed to suit your installation.

### Linear Floor Drain Trim detail (Two-way fall)

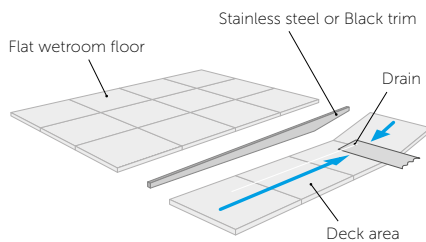

ITEM	DIMENSIONS	S/STEEL	£ Inc VAT	BLACK	£ Inc VAT
Tile strip 1	300/600mm	NWFSS1	58.52	NWFSS1H	129.68
Tile strip 2	600/600mm	NWFSS2	67.42	NWFSS2H	164.61
Tile strip 3	300/900mm	NWFSS3	67.42	NWFSS3H	145.10
Tile strip 4	300/1200mm	NWFSS4	82.68	NWFSS4H	151.60
Tile strip 5	300/1500mm	NWFSS5	92.86	NWFSS5H	189.81
Tile strip 6	900/900mm	NWFSS6	92.86	NWFSS6H	219.04
Tile strip 7	300/700mm	NWFSS7	67.42	NWFSS7H	186.38

Supplied separately, the trim provides a stylish stainless steel finish detailing the difference in tile heights where the sloping wetroom floor meets the flat wetroom floor.

### Linear Wall Drain Trim detail (One-way fall)

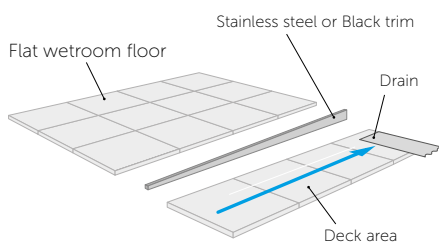

ITEM	DIMENSIONS	S/STEEL	£ Inc VAT	BLACK	£ Inc VAT
Tile strip 1	12 x 800mm	LINTT500	55.97	LINTT-500H	112.04
Tile strip 2	12 x 1000mm	LINTT700	55.97	LINTT-700H	123.83
Tile strip 3	12 x 1100mm	LINTT800	55.97	LINTT-800H	150.29
Tile strip 4	12 x 1200mm	LINTT900	55.97	LINTT-900H	150.29
Tile strip 5	12 x 1300mm	LINTT1000	67.42	LINTT-1000H	150.29
Tile strip 6	12 x 1400mm	LINTT1100	67.42	LINTT-1100H	162.99
Tile strip 7	12 x 1500mm	LINTT1200	67.42	LINTT-1200H	162.99
Tile strip 8	12 x 1800mm	LINTT1500	67.42	LINTT-1500H	188.19

For full details of waterproofing for concrete floors see page 28.

\* All of our wetroom products are covered by the Novellini Product Lifetime Guarantee. Our guarantee is valid only if used with Novellini products and does not cover installation.

# Concrete Floor - Waterproofing

## A guide to Waterproofing your wetroom

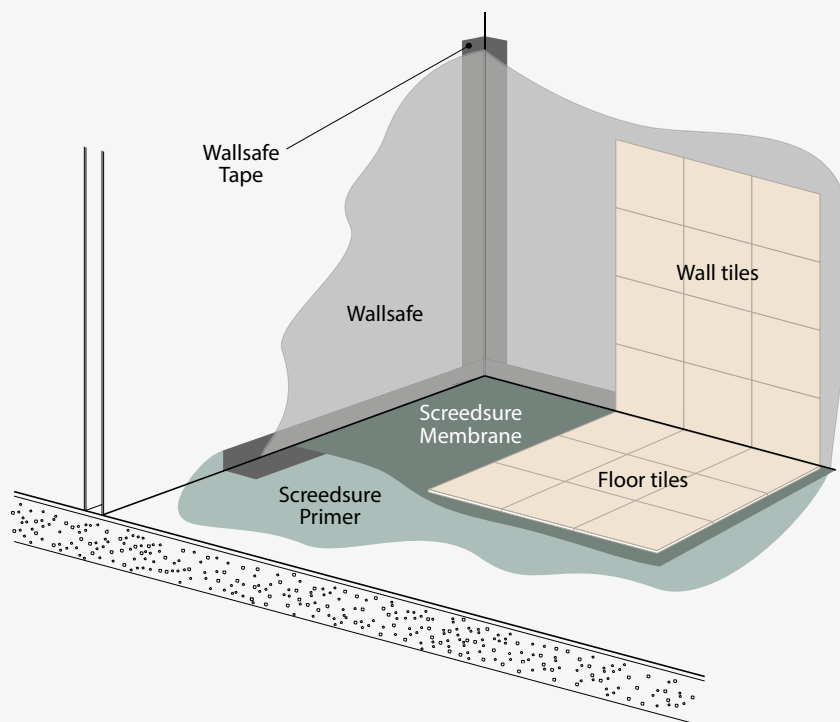

### The importance of Waterproofing

The primary concern for anyone choosing to create a wetroom is whether the floor or walls will either absorb, or worse let water through.

Through our painstaking research and development we have created a system that is guaranteed, not just for a few years, but for life.

The two components of this system are Screedsure and Wallsafe - products for waterproofing the wetroom floor and walls.

**Scredsure** is a copolymer self-adhesive waterproofing membrane specifically designed for use onto screeded and other solid floors in wetrooms and bathrooms.

Scredsure is comprised of a 1mm butyl based membrane, with a fabric top layer, providing an excellent surface for the adhesion of natural stone, porcelain and ceramic tiles.

Scredsure is quick and easy to apply, providing a consistent waterproof layer, guaranteed not to leak.

For walls we recommend **Wallsafe**: A flexible single application paint-on waterproofing membrane, applied to the wall surfaces prior to the application of ceramic tiles and/or natural stone in wetrooms.

### Application

For solid floors we recommend that the Scredsure membrane is applied to the shower area plus an additional one metre in either direction.

Wallsafe should then be applied to the walls of the shower area and overlapped onto the Reinforcing Tape.

### 3 Select Membrane Kit

### 4 Select Wall Membrane & Tape

## Floor Membrane Kit



- Suitable for solid floors only
- Self-adhesive - quick and easy to apply
- Ready to tile immediately
- Ideal for fast track construction
- Supplied as a kit
- Factory controlled thickness
- Compatible with electric underfloor heating up to 150kw per m<sup>2</sup>

#### Scredsure 5m<sup>2</sup> Kit

500ml Primer, 10m Reinforcing tape, 5m x 1m Membrane, 290ml Jointing Compound  
4 x Pre-formed corners

#### Scredsure 10m<sup>2</sup> Kit

1ltr Primer, 15m Reinforcing tape, 10m x 1m Membrane, 290ml Jointing Compound  
4 x Pre-formed corners

ITEM	CODE	PRICE £ INC VAT
5m Roll + Ancillaries	SSURE5	389.24
10m Roll + Ancillaries	SSURE10	576.22

## Additional Reinforcing Tape



A self-adhesive reinforcing tape for use with Scredsure. Reinforcing tape is 125mm wide.

#### Scredsure Reinforcing Tape

10m roll

ITEM	CODE	PRICE £ INC VAT
Scredsure Tape 10m	TAPEU10	99.22

## Wall Membrane



**Wallsafe  
Wall Membrane**



**Wallsafe  
Reinforcing Tape**

#### Wallsafe Membrane

- Quick and easy single coat application
- Compatible with Tilesure and Floorsafe
- Solvent free - covers up to 8m<sup>2</sup>
- Suitable for all commonly encountered substrates

#### Wallsafe Reinforcing Tape

- 75mm wide x 10m
- Self-adhesive
- For use in corner wall junctions, vertical joints, soap recesses and other such detail

ITEM	CODE	£ INC VAT
Wallsafe Liquid 8kg	WSAFE8	124.66
Wallsafe Tape 75mm	WSAFET10	59.79

# ▶ Glass

## Selecting your glass



### Considerations when selecting Glass

Selecting your screen is a personal choice and with our range of thousands of combinations, we are confident we can provide a layout to suit your requirements.

From raw materials through to semi-processed goods and assembly of the various components, each manufacturing stage is carefully planned, monitored and tested to ensure the highest levels of quality required by a global market.

### Easy to keep clean

Each glass panel is treated with 'crystal clear' treatment which reduces build up of limescale leaving the glass mark free.

### Safety Glass

All our products are designed to meet the latest EU quality and safety standards.



# Kuadra H & H2

## Kuadra H - single screen



WIDTH CMS <sup>2</sup>	FRAME COLOUR	GLASS THICKNESS MM	SUPPORT WIDTH CMS <sup>2</sup>	PRODUCT CODE	PRICE £ INC VAT
30	CHROME	8	100	KUADH30-1K	456.58
30	BLACK	8	100	KUADH30-1H	456.58
40	CHROME	8	100	KUADH40-1K	456.58
40	BLACK	8	100	KUADH40-1H	456.58
50	CHROME	8	100	KUADH50-1K	541.49
50	BLACK	8	100	KUADH50-1H	541.49
60	CHROME	8	100	KUADH60-1K	541.49
60	BLACK	8	100	KUADH60-1H	541.49
70	CHROME	8	100	KUADH70-1K	622.23
70	BLACK	8	100	KUADH70-1K	622.23
75	CHROME	8	100	KUADH75-1K	622.23
75	BLACK	8	100	KUADH75-1H	622.23
80	CHROME	8	100	KUADH80-1K	707.14
80	BLACK	8	100	KUADH80-1H	707.14
90	CHROME	8	100	KUADH90-1K	707.14
90	BLACK	8	100	KUADH90-1H	707.14
100	CHROME	8	100	KUADH100-1K	707.14
100	BLACK	8	100	KUADH100-1H	707.14
110	CHROME	8	100	KUADH110-1K	787.88
110	BLACK	8	100	KUADH110-1H	787.88
120	CHROME	8	100	KUADH120-1K	787.88
120	BLACK	8	100	KUADH120-1H	787.88
130	CHROME	8	100	KUADH130-1K	871.40
130	BLACK	8	100	KUADH130-1H	871.40
140	CHROME	8	100	KUADH140-1K	871.40
140	BLACK	8	100	KUADH140-1H	871.40
150	CHROME	8	100	KUADH150-1K	954.92
150	BLACK	8	100	KUADH150-1H	954.92
160	CHROME	8	100	KUADH160-1K	954.92
160	BLACK	8	100	KUADH160-1H	954.92

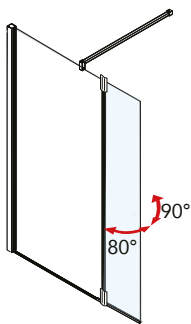

## Kuadra HFA - flipper panel only

WIDTH CMS <sup>2</sup>	FRAME COLOUR	GLASS THICKNESS MM	SUPPORT WIDTH CMS <sup>2</sup>	PRODUCT CODE	PRICE £ INC VAT
37	CHROME	8	N/A	KUADHA37-1K	162.87
37	BLACK	8	N/A	KUADHA37-1H	162.87

## Kuadra H2 - screen with pivoting screen



WIDTH CMS <sup>2</sup>	FRAME COLOUR	GLASS THICKNESS MM	SUPPORT WIDTH CMS <sup>2</sup>	PRODUCT CODE	PRICE £ INC VAT
68 + 37	CHROME	8	100	KUADH268-1K	744.72
78 + 37	CHROME	8	100	KUADH278-1K	825.46
88 + 37	CHROME	8	100	KUADH288-1K	825.46
98 + 37	CHROME	8	100	KUADH298-1K	825.46

### Notes for all Kuadra screens

1. The width of the screen allows for up to a 30mm variation in the wall.
2. All Kuadra screens are 200cm in height.

## ▶ Glass

### Kuadra H Squares & Stripes



The impact of a bathroom in which strong shades of black are used is unequalled; this latest interior trend is inspired by the robust industrial look of yesteryear.

Black is a powerful, elegant and luxurious colour. It enhances shapes and emphasises contrasts. Black also radiates energy and vitality.

The glass options shown in this brochure are a suggestion, for our complete solution please visit: [www.novellini.co.uk](http://www.novellini.co.uk)



# Kuadra H Squares & Stripes

## Kuadra H Squares

Create your enclosure by ordering two screens. Details and prices below are per screen.



Kuadra H Squares with optional evo bar

WIDTH CMS	HEIGHT CMS	GLASS THICKNESS	PRODUCT CODE	PRICE £ INC VAT
77-80	200	8	KUADH80-81H	840.77
87-90	200	8	KUADH90-81H	840.77
97-100	200	8	KUADH100-81H	840.77
117-120	200	8	KUADH120-81H	921.51
137-140	200	8	KUADH140-81H	1005.03
157-160	200	8	KUADH160-81H	1088.55

**NB - Two screens must be ordered together to make a complete enclosure.**

## Kuadra H Stripes

Create your enclosure by ordering two screens. Details and prices below are per screen.



Kuadra H Stripes with optional evo bar

WIDTH CMS	HEIGHT CMS	GLASS THICKNESS	PRODUCT CODE	PRICE £ INC VAT
77-80	200	8	KUADH80-82H	840.77
87-90	200	8	KUADH90-82H	840.77
97-100	200	8	KUADH100-82H	840.77
117-120	200	8	KUADH120-82H	921.51
137-140	200	8	KUADH140-82H	1005.03
157-160	200	8	KUADH160-82H	1088.55

**NB - Two screens must be ordered together to make a complete enclosure.**

## ▶ Glass

**Young** - the complete enclosure for corner or alcove



### Benefits of the Young range

Combining minimalist design with strength, Young enclosures exude style and quality with their low profile frame, robust door hinges and metal door handle for ease of operation. With no door thresholds they are particularly suitable for installation directly on to tiled floors making them perfect for wetroom installation.

Young doors open inwards as well as outwards, enabling you to fold the shower enclosure back when not in use - great for saving space in smaller wetrooms.

**The glass options shown in this brochure are a suggestion, for our complete solution please visit: [www.novellini.co.uk](http://www.novellini.co.uk)**

# Young

## Young Corner - two doors, both hinged

Create your enclosure by ordering two sides. Details and prices below are per side.



WIDTH CMS <sup>1</sup>	HEIGHT CMS <sup>2</sup>	GLASS THICKNESS <sup>3</sup>	PRODUCT CODE	PRICE £ INC VAT
77-79	200	6	Y22G77-L1K	566.55
79-81	200	6	Y22G79-L1K	566.55
85-87	200	6	Y22G85-L1K	566.55
87-89	200	6	Y22G87-L1K	591.60
89-91	200	6	Y22G89-L1K	591.60
95-97	200	6	Y22G95-L1K	591.60
97-99	200	6	Y22G97-L1K	616.66
99-101	200	6	Y22G99-L1K	616.66

**NB - LEFT and RIGHT hand screens must be ordered together to make a complete enclosure.**

## Young Corner - one hinged door, one fixed side panel

Create your enclosure by ordering one door (right hand or left hand side) and one fixed side panel.



WIDTH CMS <sup>1</sup>	HEIGHT CMS <sup>2</sup>	GLASS THICKNESS <sup>3</sup>	PRODUCT CODE	PRICE £ INC VAT
<b>HINGED DOORS</b>				
77-79	200	6	Y2G77-1K	566.55
79-81	200	6	Y2G79-1K	566.55
85-87	200	6	Y2G85-1K	566.55
87-89	200	6	Y2G87-1K	591.60
89-91	200	6	Y2G89-1K	591.60
95-97	200	6	Y2G95-1K	591.60
97-99	200	6	Y2G97-1K	616.66
99-101	200	6	Y2G99-1K	616.66
<b>SIDE PANEL</b>				
77-79	200	6	Y2FG77-1K	520.61
79-81	200	6	Y2FG79-1K	520.61
85-87	200	6	Y2FG85-1K	551.24
87-89	200	6	Y2FG87-1K	551.24
89-91	200	6	Y2FG89-1K	551.24
95-97	200	6	Y2FG95-1K	551.24
97-99	200	6	Y2FG97-1K	580.47
99-101	200	6	Y2FG99-1K	580.47

### Notes for all Young screens

- All young screens are reversible or have left or right hand options.
  - All Young screens feature clear glass with Crystal Clear treatment and a chrome frame.
  - A 100cm horizontal support bar is included with the side panel. See page 31 for more options.
1. The width of the screen allows for up to a 40mm variation in the wall.
  2. The support bar, included in every pack, adds a further 1cm in height to the figures indicated.
  3. 6mm safety glass.

# ▶ Glass - Young

## Young Alcove with single folding door



WIDTH CMS <sup>1</sup>	HEIGHT CMS <sup>2</sup>	GLASS THICKNESS <sup>3</sup>	PRODUCT CODE	PRICE £ INC VAT
72-76	200	6	Y21BS72-1K	818.50
77-81	200	6	Y21BS77-1K	849.12
82-86	200	6	Y21BS82-1K	879.75
87-91	200	6	Y21BS87-1K	879.75
94-98	200	6	Y21BS94-1K	911.76
97-101	200	6	Y21BS97-1K	911.76
107-111	200	6	Y21BS107-1K	925.68
117-121	200	6	Y21BS117-1K	942.39

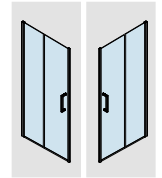

LEFT RIGHT

**NB - Please state LEFT or RIGHT hand screen when ordering.**

## Young Alcove with single door and fixed inline panel



WIDTH CMS <sup>1</sup>	HEIGHT CMS <sup>2</sup>	GLASS THICKNESS <sup>3</sup>	PRODUCT CODE	PRICE £ INC VAT
97-101	200	6	Y2GFL97-1K	831.03
114-118	200	6	Y2GFL114-1K	871.40
117-121	200	6	Y2GFL117-1K	871.40
137-141	200	6	Y2GFL137-1K	975.80
147-151	200	6	Y2GFL147-1K	1002.24
157-161	200	6	Y2GFL157-1K	1031.48
167-171	200	6	Y2GFL167-1K	1048.18
177-181	200	6	Y2GFL177-1K	1060.71

## Young Corner with two hinged and folding doors

Create your enclosure by ordering two sides. Details and prices below are per side.



WIDTH CMS <sup>1</sup>	HEIGHT CMS <sup>2</sup>	GLASS THICKNESS <sup>3</sup>	PRODUCT CODE	PRICE £ INC VAT
77-79	200	6	Y22GS77L-1K	643.11
79-81	200	6	Y22GS79L-1K	672.34
85-87	200	6	Y22GS85L-1K	672.34
87-89	200	6	Y22GS87L-1K	672.34
89-91	200	6	Y22GS89L-1K	672.34
95-97	200	6	Y22GS95L-1K	700.18
97-99	200	6	Y22GS97L-1K	700.18
99-101	200	6	Y22GS99L-1K	700.18
115-117	200	6	Y22GS115L-1K	700.18
117-119	200	6	Y22GS117L-1K	729.41

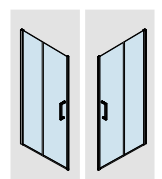

LEFT RIGHT

**NB - LEFT and RIGHT hand screens must be ordered together to make a complete enclosure.**

## Additional products



### Evo Fixing System - Corner Version

(Supplied with 2 clamps and a corner piece)

FRONT BAR MAX WIDTH (cms)	SIDE BAR MAX WIDTH (cms)	PRODUCT CODE	COLOUR	PRICE £ INC VAT
180	120	KUADHSF-B	SILVER	263.09
180	120	KUADHSF-K	CHROME	263.09



### Evo Fixing System - Recess Version

FRONT BAR MAX WIDTH (cms)	SIDE BAR MAX WIDTH (cms)	PRODUCT CODE	COLOUR	PRICE £ INC VAT
180	120	KUADHSFN-B	SILVER	180.96
180	120	KUADHSFN-K	CHROME	180.96



### Optional corner support for Kuadra and Young

WIDTH (cms)	PRODUCT CODE	PRICE £ INC VAT
25	R80LOU250-K	80.74
35	R80LOU350-K	87.70
45	R80LOU450-K	94.66



### Optional long support bar for Kuadra only

COLOUR	WIDTH (cms)	PRODUCT CODE	PRICE £ INC VAT
CHROME	150	R80GIANF15-K	111.36



### Optional ceiling kit for Kuadra only

(to be used with supplied support bar)

COLOUR	PRODUCT CODE	PRICE £ INC VAT
CHROME	R801SOFEL-K	50.12



### Chrome Aluminium bottom profile for 6/8mm glass

PROFILE LENGTH	PRODUCT CODE	PRICE £ INC VAT
100cm	P51BOHU10-K	41.76
150cm	P51BOHU15-K	51.51

## ► Inspiration

**New ideas** - further details on [novellini.co.uk](http://novellini.co.uk)



### Inspiration

If you are looking for something a little more creative from your bath or shower room then we have something special to inspire you.

Investment in in-Art HD glass printing technology has enabled us to create our latest range of contemporary shower screens.

These designs allow you to create a feature wetroom that is way beyond ordinary.

In addition to the shower screens we also produce our own bathroom furniture. By selecting from our Divina Bath range and lotti furniture you can complete the look for your bespoke bath or shower room.



The image above features baths from our Divina range.

All furniture is courtesy of our Lotti collection and the shower head and controls are 'Easy Shower'. The glass is Kuadra H with Black Edging.

The two glass options below show our creative flair with the Kuadra H 'Grid' to the left and Kuadra H 'Wires' to the right.

For more details please visit [novellini.co.uk](http://novellini.co.uk)



UK Head Office  
Novellini UK Ltd  
Unit 11  
Caxton Court  
Porters Wood  
St Albans  
Hertfordshire  
AL3 6XT

e: [info-uk@novellini.com](mailto:info-uk@novellini.com)  
[wetrooms.novellini.co.uk](http://wetrooms.novellini.co.uk)

t: 01727 229922  
f: 01727 838232

**wetroom technical support: 01256 766757**

**WEBSITE**



**LINK**

