

WETROOMS & GLASS



 **NOVELLINI**

+9%

ENCLOSURES - SCREENS
BRACKETS - ACCESSORIES

+6%

TRAYS - WETROOMS

 **NOVELLINI**



Contents

Section	Page
Contents	3
What is a Wetroom?	4-5
Choosing your floor style	6-7
Choosing a layout	8-9
Timber floor	
Guidelines	10-11
Mono Deck range	12-15
Duo Deck range	16-17
Quattro Deck range	18-19
Waterproofing	20-21
Concrete floor	
Guidelines	22-23
Drains & Grills	24-26
Linear Graded Board/Trim	27
Waterproofing	28-29
Glass	
How to select	30
Screens - Kuadra	31-33
Enclosures - Young Corner	34-35
Enclosures - Young Alcove	36
Additional products	37
Inspiration	38-39

What is a Wetroom?

At Novellini we understand that you desire something more individual than just a shower room. That's why we've created a comprehensive wetroom and glass collection that features a range of both stylish and practical solutions for your home.

Our wetrooms offer all the benefits of a walk-in shower, combined with the protection offered by a shower screen or enclosure, allowing you to create a contemporary, luxurious feel to any bathroom.

Using the available space in an efficient and uncluttered manner allows you to create a truly individual showering experience, limited only by your imagination.

Peace of Mind

Our designers and engineers work with one common goal: to design and manufacture wetroom solutions that are fully integrated. From the hidden technology under the wetroom floor, to our beautifully designed glass screens and enclosures.

Lifetime Guarantee

All of our wetroom products are covered by the Novellini Product Lifetime Guarantee. Our guarantee is valid only if used with Novellini products and does not cover installation.



The Complete Package

We offer wetroom solutions for both timber and concrete floors with all systems encompassing the four key components of a wetroom:

- 1 Gradient
- 2 Drainage
- 3 Waterproofing
- 4 Glass



Key aspects of a Novellini Wetroom

1 Gradient

It is important to ensure that the floor of a wetroom has sufficient gradient in order for the water to drain away without forming puddles. Our system offers a choice of pre-formed, engineered slopes guaranteeing a perfect gradient every time.

2 Drainage

Whether you desire a contemporary linear drain or a more traditional square outlet you need to be sure that the drain is capable of taking away sufficient water to keep up with the flow from the shower head. Our drains offer the choice of an additional trap, therefore ensuring sufficient drainage is available.

3 Waterproofing

It is essential to ensure your wetroom is correctly waterproofed. All of our membranes are easy to apply and are backed up by our Lifetime Guarantee, offering complete peace of mind.

4 Glass

Our range of screens and enclosures offer almost unlimited choice, from the simplicity of a single screen right through to our full enclosures and multi-screen options.

► Choosing your floor style

The secret to a successful wetroom

The Wetroom Deck

Our range of preformed decks have been developed specifically to allow the installation of a wetroom onto a timber floor, which are quick and easy to install. Each Deck has a built-in gradient that flows towards the stylish drain to create a perfect wetroom every time.

Choose from:

Mono Deck - One way fall

Duo Deck - Two way fall

Quattro Deck - Four way fall

For Concrete Floors see pages 22-29

Mono Deck - One way fall for large format tiles



Benefits of the Mono Deck

The Mono Deck is a single slope wetroom system for timber floors, allowing the linear drain to be positioned neatly against the wall, giving a sleek stylish finish.

See p12-15 for details

Duo Deck - Two way fall for large format tiles



Benefits of the Duo Deck

The Duo Deck, with its contemporary linear drain, is perfect for 'large format' tiles, as there are fewer tile cuts required and hence fewer grout lines.

See p16-17 for details

Quattro Deck - Four way fall for mosaic tiles

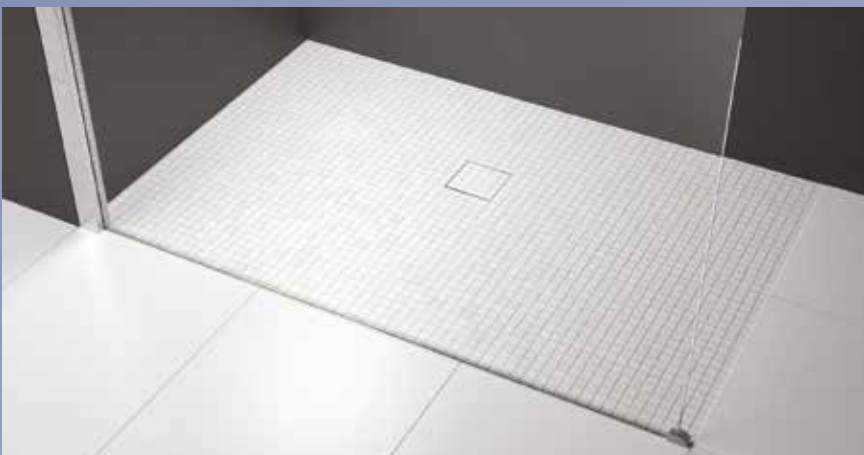

Benefits of the Quattro Deck

The Quattro Deck, with its more traditional square drain, is better suited to smaller 'Mosaic' tiles as the tiles blend more sympathetically into the shape of the Deck.

See p18-19 for details

▶ Choosing a layout to suit your room Corner, alcove or wall layout?



Selecting a layout

The layout of your shower room will determine the glass option required. Typically this will be either a Corner, Alcove or Wall Layout. For the Corner Layout we provide a range of options from the minimalist single panel to the complete enclosure. For the Alcove there is a choice of either a minimal screen with pivot or a single door (with a fixed panel if required). For the Wall Layout we provide a choice of fixed screens with optional side panels.

How wide should a screen be?

To keep water within shower area A, a minimum of 100cm is acceptable, but 120cm would be preferable. Your glass choice will also be affected by area B which is the amount of aperture you need to enter the shower area. If space is limited, a Kuadra H2 (p27) screen with pivot offers a smaller fixed panel with enhanced shielding.

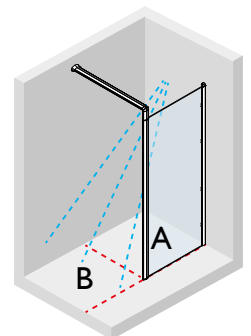

1. Corner Layout

For simplicity, select a single glass screen (Kuadra H) but ensure the width of the screen is sufficient to contain the water spray. For more control, choose a screen with a pivot (Kuadra H2) which deflects more water back into the shower area.

Combine screens to form your (Multi-screen) enclosure or choose a Young enclosure to completely contain the water and retain heat within the shower area.

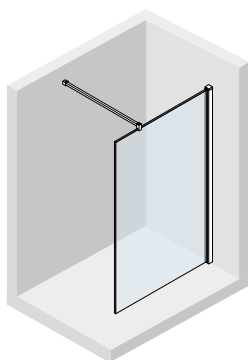

Single glass

Kuadra H
See p31

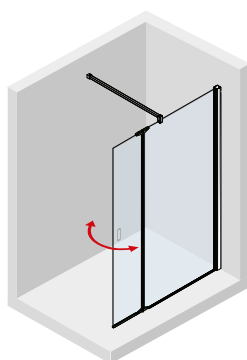

Screen with pivot

Kuadra H2
See p31

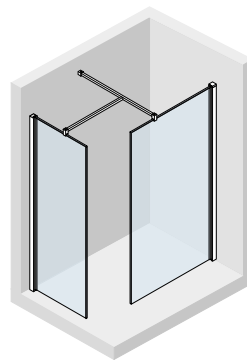

Multi-screen

Kuadra H with H or H2
See p31

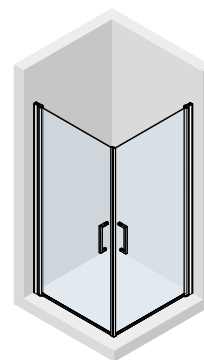

Enclosure

Young
See p36

2. Alcove Layout

Where your shower area is within an alcove, we provide a minimal screen with pivot (Kuadra H2) or a single door (with fixed panel if required) (Young).

3. Wall Layout

Create the feeling of space with a wall layout - perfect for a 'dual' shower. Kuadra Wall features different screen widths along with options for fixed side panels.



Screen with pivot

Kuadra H2
See p31

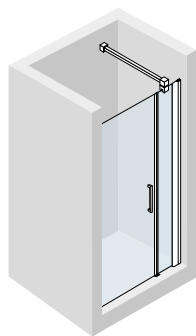

Single door (+panel)

Young
See p36

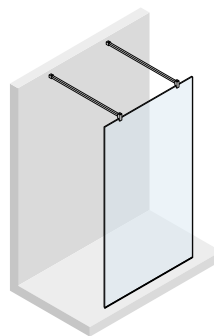

Single glass

Kuadra Wall
See Main Catalogue

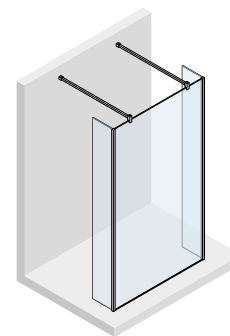

Single glass with panels

Kuadra Wall
See Main Catalogue

Timber Floor - Guidelines

The Novellini wetroom for Timber Floors

Introduction

Our range of pre-formed shower Decks has been developed specifically to allow the installation of a level access wetroom on a timber floor.

Available in a range of sizes, the Deck has a pre-formed engineered slope, ensuring that water from the shower

is directed towards the integral drain, guaranteeing a perfect gradient every time.

Novellini Wetroom floor systems can be installed with electric underfloor heating (max specification 150watts/ sq metre).

Typical timber floor build-up - Duo Deck

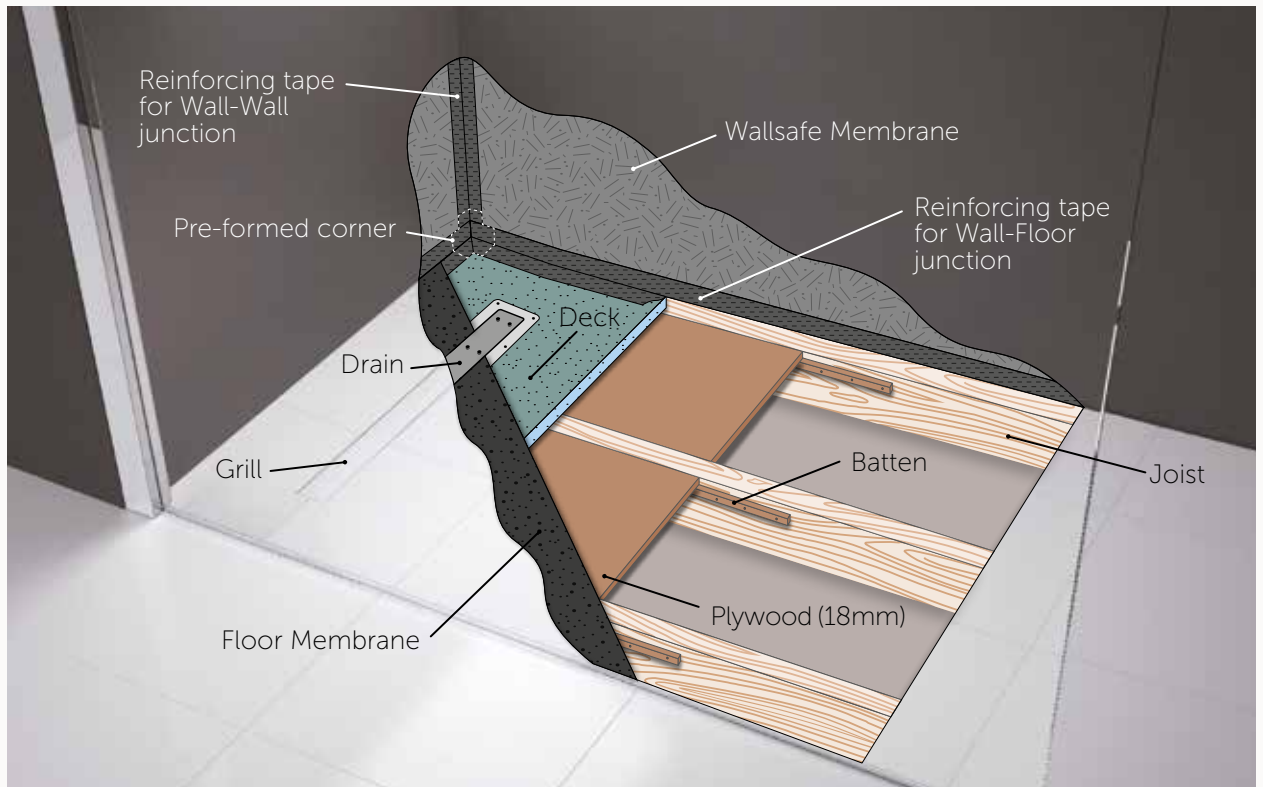

The Drain and Deck are supported by plywood held in place between the floor joists by battens.

The Deck is covered by a self-adhesive waterproof membrane supplied as a Floor Membrane Kit.

The wall is sealed with a waterproof Wall Membrane.

The internal corner of the wetroom is protected using a Pre-formed corner, while the wall-floor horizontal joints and wall-wall vertical joints are sealed with reinforcing tape.

Three simple steps to order your Timber Floor solution

1 Deck & Drain



Flow rate up to
68 L/min

Mono Deck

One-way fall with linear drain



Flow rate up to
41 L/min

Duo Deck

Two-way fall with linear drain



Flow rate up to
24 L/min

Quattro Deck

Four-way fall with square drain

The preformed engineered slope on all Decks guarantees a perfect gradient every time.

Choose either the Mono Deck or Duo Deck for large format tiles, or the Quattro Deck for mosaic tiles.

Each Deck features a multi-directional trap for ease of installation.

For Mono and Duo Decks, additional traps can be added to increase the flow rate.



Tilesure Floor Membrane Kit



Floorsafe Floor Membrane Kit

2 Floor Membrane Kit

It is essential to ensure your wetroom is correctly waterproofed.

Choose from either a Tilesure or Floorsafe Kit. Both Kits comprise a Floor Membrane, Primer, Pre-formed corners and Reinforcing Tape.



Wallsafe Wall Membrane



Wallsafe Reinforcing Tape



Tilesure Reinforcing Tape



Floorsafe Reinforcing Tape

3 Wall Membrane & Tape

Use Wallsafe to waterproof the walls within and around the shower area.

Use Reinforcing Tape for sealing critical Wall-Wall and Wall-Floor joints.

Ensure the correct Tape is used with the appropriate Floor Membrane Kit.

For full details of waterproofing for timber floors see page 20-21.

* All of our wetroom products are covered by the Novellini Product Lifetime Guarantee. Our guarantee is valid only if used with Novellini products and does not cover installation.

Mono Deck - How to Specify

Designed for use with large format tiles, Mono Dec is a trimmable wetroom base for timber floors, with a one-way fall towards a linear drain, therefore eliminating the need for diagonal tile cuts.

When choosing the correct kit please take the following into consideration:

- Size of the required shower area
- Position of the drain – On the long wall or short wall
- Number of traps – 1, 2 or 3
- Finish of the linear grill – Type G1 Solid or G3 Stone-Infill
- For grill lengths see Mono Kits on p15

For grill lengths see Mono Kits on p15. Simply choose the nearest kit to the required size of the shower area.

Remember - The width and length can be trimmed on-site to achieve the required size.

Example below shows Kit 8, trimmed to suit a shower area:

- Drainage Component*
- Single Horizontal Trap
- Infill Panel*
- Graded Board*
- G3 Wall Grill
- Stainless Steel Tile Trim

* Trimmable on-site

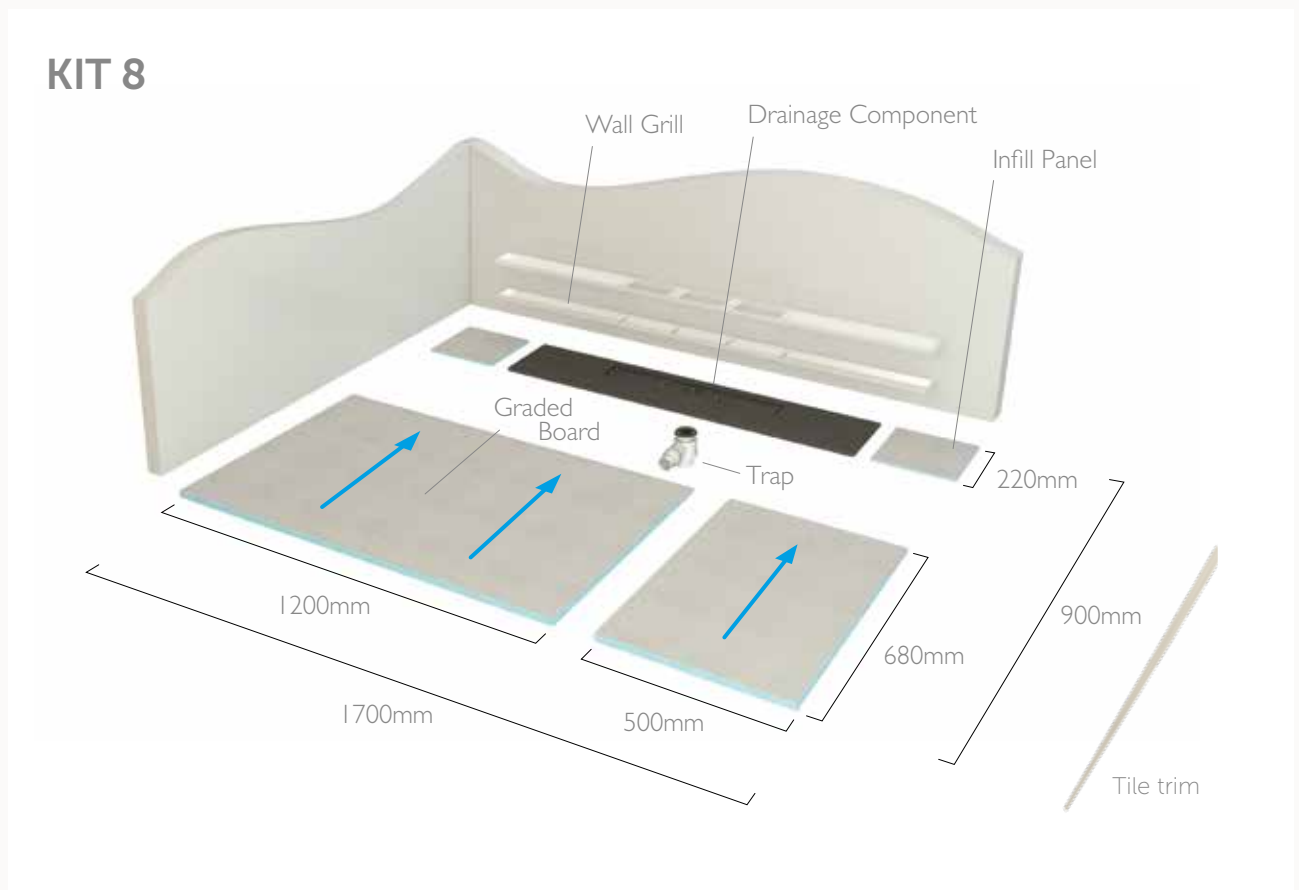

Drainage Component

The Drainage Component is the central element of the Mono Deck System, once in position, the rest of the system is built around it.



- Width can be trimmed on-site
- Available with 1, 2 or 3 wastes
- Single trap up to 24 L/min
- Double trap up to 41 L/min
- Triple trap up to 68 L/min
- 360° Rotatable trap with 42mm outlet
- Trap can be positioned off-center to avoid joists
- Single trap supplied as standard, additional traps can be added as required, see page 15.

Linear Grill

The Mono Deck is supplied with a Linear Grill, which is neatly positioned against the wall, therefore eliminating the need for angled tile cuts. The grill will be supplied up to 300mm shorter than the overall shower.

i.e. Kit 8 (see p12) has a maximum size of 1800mm x 1000mm with the drain positioned against the long wall, therefore the grill supplied is 1500mm. Simply choose either G1 Solid or G3 Stone Infill.

Drain positioned against the long wall.

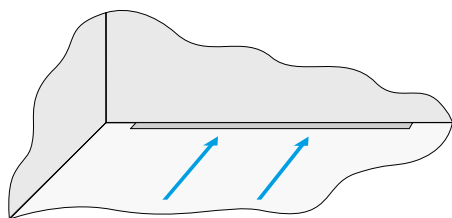

Drain positioned against the short wall.

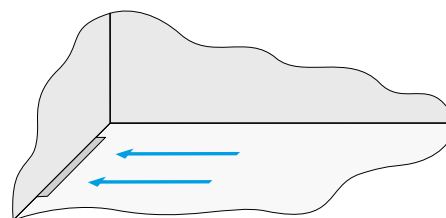

Graded Board

The Graded Board provides an easy to install one way-fall towards the linear drain. Manufactured from high density XPS, they are trimmable along both dimension A & B, allowing a shower area to be created of almost any size.

- 22mm to 11mm gradient
- Trimmable
- High compressive strength
- Supplied with stainless steel Tile trim
- Fixing washers included
- Easy to install - no angled tile cuts

Infill Panel

- 11mm thickness
- Trimmable
- Fixing washers include

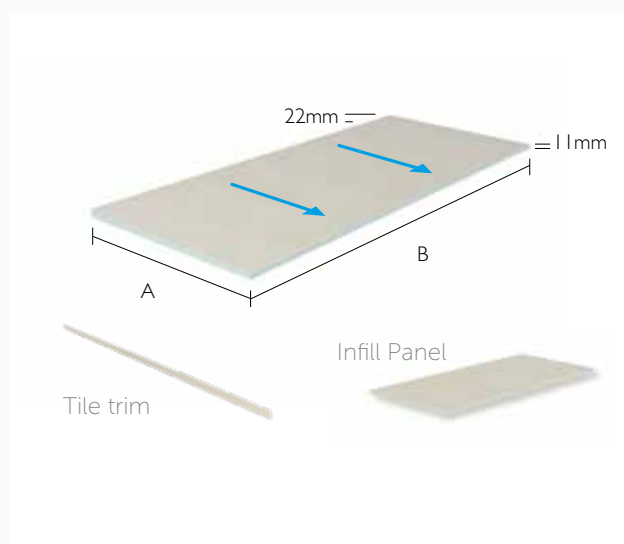

For full details of waterproofing for timber floors see page 20-21.

* All of our wetroom products are covered by the Novellini Product Lifetime Guarantee. Our guarantee is valid only if used with Novellini products and does not cover installation.

Timber Floor - Mono Deck

Features of a Mono Deck

The Mono Deck has a single slope one-way fall and can be installed with the linear drain positioned against the long wall or the short wall. The features of a Mono Deck are summarised below:

- Single slope one-way fall
- Create a shower area almost any size
- Easy to install
- Easy to tile using large format tiles
- Lifetime Guarantee

Drain position

Positioning the drain against the wall provides a one-way gradient within the shower, ensuring the user is not standing on the drain. This also omits the need for diagonal tile cuts, giving a more stylish look which is both easier to install and maintain.

Drain against Short Wall

Corner layout

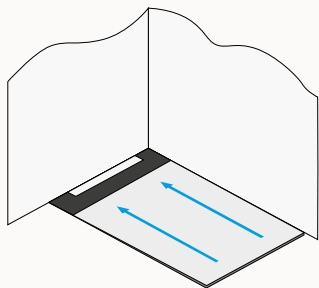

Drain against Long Wall

1. Corner layout

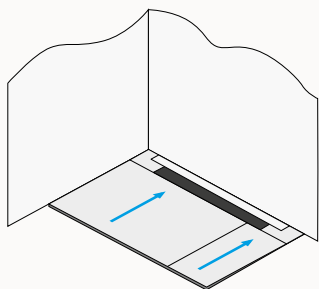

2. Alcove layout

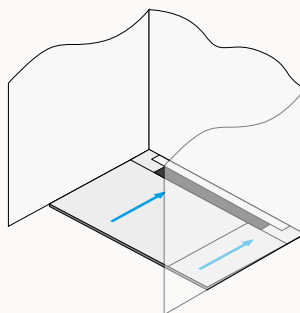

3. Wall layout

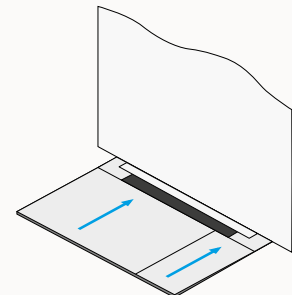

1 Select your **Mono Kit** and **Grill**. Add additional trap if required.



Mono Kits

SHORT WALL LAYOUT*	DIMENSION** A	DIMENSION** B	GRILL LENGTH G1/G3	PRODUCT CODE	PRICE £ INC VAT
	1000mm 1200mm 1400mm 1700mm	800 - 1000mm	700mm	MONOKIT1 G1	760.80
				MONOKIT1 G3	834.00
				MONOKIT2 G1	811.20
				MONOKIT2 G3	883.20
				MONOKIT3 G1	836.40
				MONOKIT3 G3	909.60
				MONOKIT4 G1	909.60
				MONOKIT4 G3	981.60

LONG WALL LAYOUT*	DIMENSION** B	DIMENSION** A	GRILL LENGTH G1/G3	PRODUCT CODE	PRICE £ INC VAT
	1200mm 1400mm 1600mm 1800mm	800 - 1000mm	900mm	MONOKIT5 G1	813.60
				MONOKIT5 G3	884.40
			1100mm	MONOKIT6 G1	1018.80
				MONOKIT6 G3	1090.80
			1300mm	MONOKIT7 G1	1058.40
				MONOKIT7 G3	1130.40
			1500mm	MONOKIT8 G1	1096.80
				MONOKIT8 G3	1170.00

* See page 14 (opposite) for details of Long and Short Wall Layouts

** Dimensions A&B can be cut down to suit your shower space.
Other board and drain sizes are available upon request.

Grill options **NB Kits with code G1 include a Solid Grill. Kits with code G3 include Stone Infill Grill.**



Item:	Solid Grill
Code:	G1



Item:	Stone Infill Grill
Code:	G3

Additional traps (if required)



Item:	Duo Extra*
Code:	DUOWA90
£ (inc VAT):	63.60

*(horizontal fast-flow trap)



Item:	Duo Optional*
Code:	DUOVT90
£ (inc VAT):	63.60

*(vertical fast-flow trap)

For full details of waterproofing for timber floors see page 20-21.

* All of our wetroom products are covered by the Novellini Product Lifetime Guarantee. Our guarantee is valid only if used with Novellini products and does not cover installation.

Timber Floor - Duo Deck

Duo Deck (with Two-way fall)

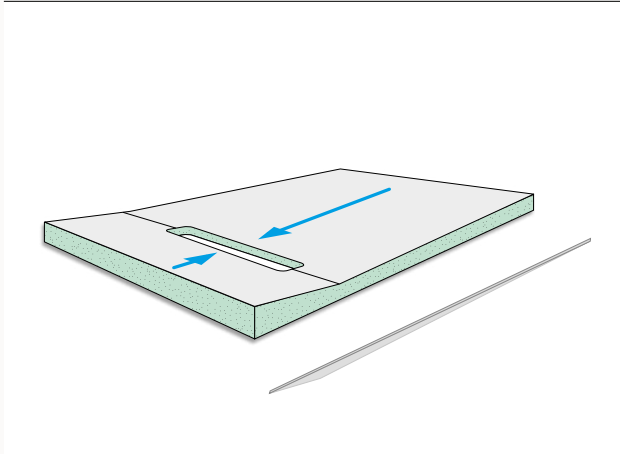

The Duo Deck - 2 way fall

Features of a Duo Deck

- Two-way fall suited to large format tiles
- Designed for timber floors
- Lifetime Guarantee
- 22mm depth
- 9 Pre-formed sizes
- Flow rate up to 41 L/min (with two traps)
- Easily trimmed (up to 50mm from any side)
- Supplied with stainless steel Tile Trim

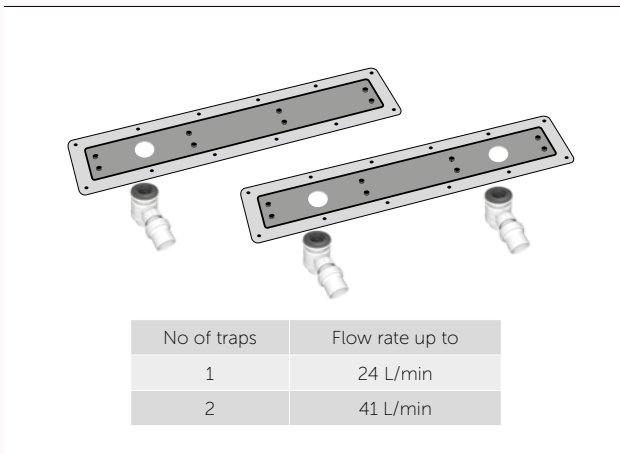

Drain and trap

Features of the drain and trap

- Contemporary linear drain
- Waste position can be varied on-site to avoid joists
- Available with two wastes
- Flow rate up to 41 L/min (with two traps)
- 360° Rotatable trap with 42mm outlet
- Height adjustable grill

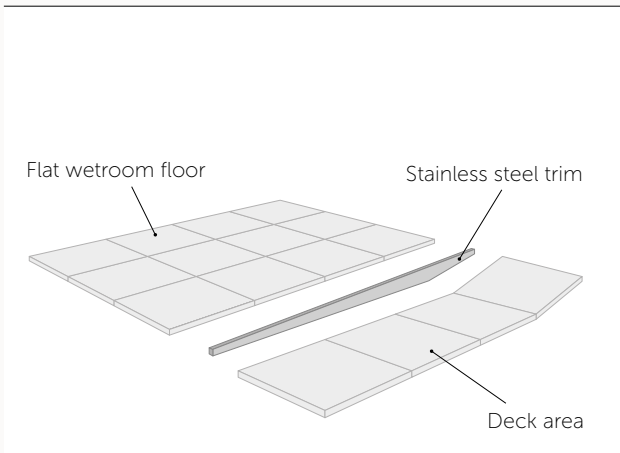

Trim detail

Trim detail

Supplied with the Deck, the trim provides a stylish stainless steel finish detailing for the difference in tile heights where the Deck meets the remainder of the wetroom floor.

1 Select your **Duo Kit** and **Grill**. Add additional trap if required.



Duo Kits

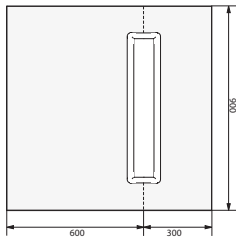

Size:	900 x 900mm
Code:	DUOKIT1G1 ...G3
£ (Inc VAT):	686.40 757.20

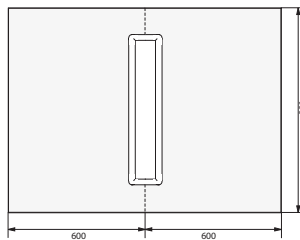

Size:	1200 x 900mm C
Code:	DUOKIT2G1 ...G3
£ (Inc VAT):	831.60 902.40

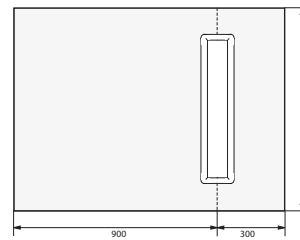

Size:	1200 x 900mm E
Code:	DUOKIT3G1 ...G3
£ (Inc VAT):	831.60 902.40

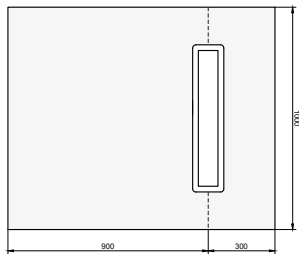

Size:	1200 x 1000mm
Code:	DUOKIT8G1 ...G3
£ (Inc VAT):	831.60 902.40

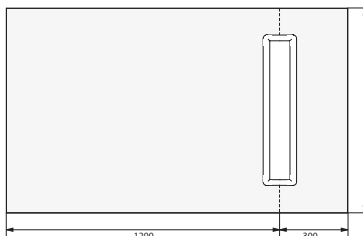

Size:	1500 x 900mm
Code:	DUOKIT4G1 ...G3
£ (Inc VAT):	958.80 1029.60

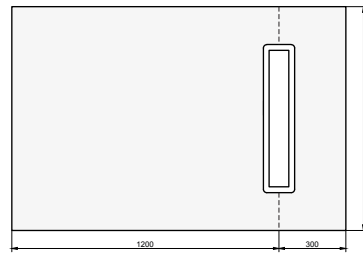

Size:	1500 x 1000mm
Code:	DUOKIT9G1 ...G3
£ (Inc VAT):	958.80 1029.60

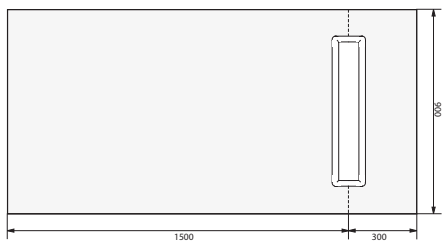

Size:	1800 x 900mm
Code:	DUOKIT5G1 ...G3
£ (Inc VAT):	1006.80 1078.80

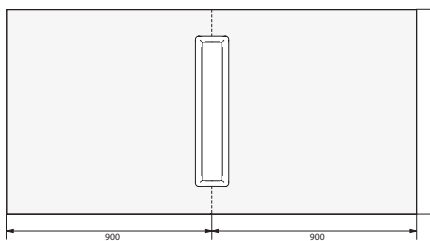

Size:	1800 x 900mm C
Code:	DUOKIT6G1 ...G3
£ (Inc VAT):	1006.80 1078.80

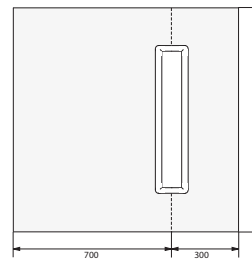

Size:	1000 x 1000mm
Code:	DUOKIT7G1 ...G3
£ (Inc VAT):	831.60 902.40

Grill options **NB Kits with code G1 include a Solid Grill. Kits with code G3 include Stone Infill Grill.**



Item:	Solid Grill
Code:	G1



Item:	Stone Infill Grill
Code:	G3

Additional traps (if required - see flow rate table opposite)



Item:	Duo Extra*
Code:	DUOWA90
£ (Inc VAT):	63.60
*(horizontal fast-flo trap)	



Item:	Duo Optional*
Code:	DUOVT90
£ (Inc VAT):	63.60
*(vertical fast-flo trap)	

For full details of waterproofing for timber floors see page 20-21.

* All of our wetroom products are covered by the Novellini Product Lifetime Guarantee. Our guarantee is valid only if used with Novellini products and does not cover installation.

Timber Floor - Quattro Deck

Quattro Deck (with Four-way fall)

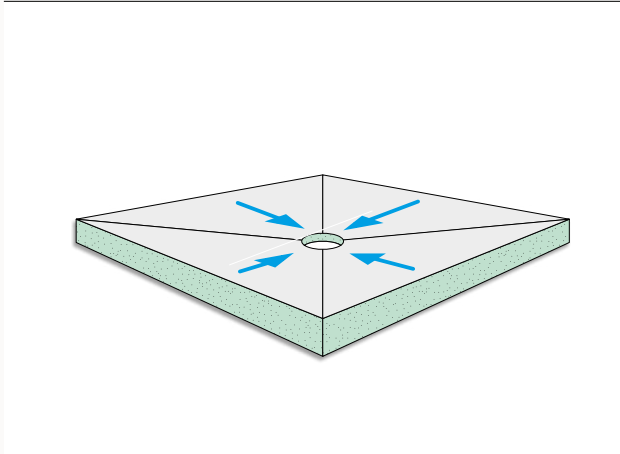

Quattro Deck

Features of a Quattro Deck

- Four-way fall suited to mosaic tiles
- Designed for timber floors
- Lifetime Guarantee
- 22mm depth
- 8 Pre-formed sizes
- Easily trimmed (up to 50mm from any side)

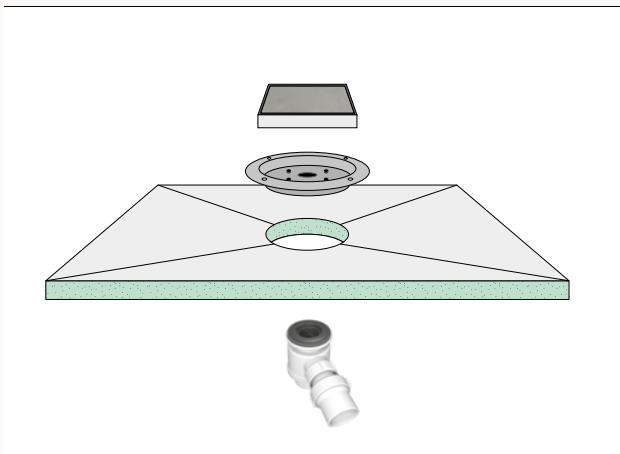

Quattro Grill, Trap and Drain

Features of the drain and trap

- Traditional square drain
- Flow rate up to 24 L/min
- 360° Rotatable trap with 42mm outlet
- Height adjustable grill

1 Select your Quattro Kit and Grill option



Quattro Kits

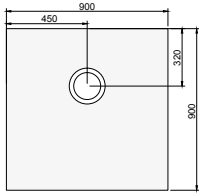

Size:	900 x 900mm
Code:	QKIT1G1 ...G3
£ (Inc VAT):	517.20 555.60

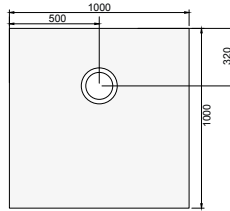

Size:	1000 x 1000mm
Code:	QKIT2G1 ...G3
£ (Inc VAT):	531.60 570.00

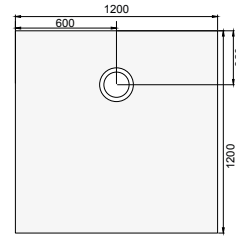

Size:	1200 x 1200mm
Code:	QKIT3G1 ...G3
£ (Inc VAT):	674.40 712.80

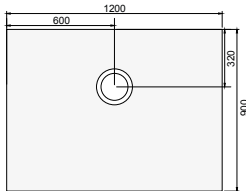

Size:	1200 x 900mm
Code:	QKIT4G1 ...G3
£ (Inc VAT):	564.00 602.40

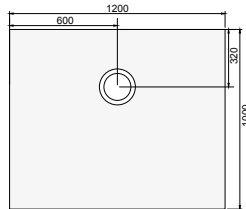

Size:	1200 x 1000mm
Code:	QKIT5G1 ...G3
£ (Inc VAT):	595.20 633.60

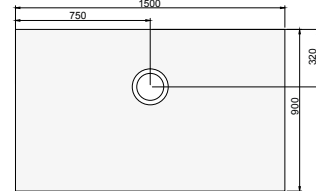

Size:	1500 x 900mm
Code:	QKIT6G1 ...G3
£ (Inc VAT):	595.20 633.60

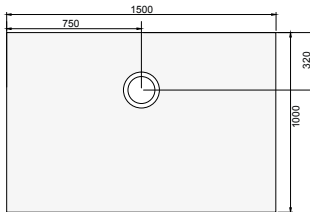

Size:	1500 x 1000mm
Code:	QKIT7G1 ...G3
£ (Inc VAT):	625.20 664.80

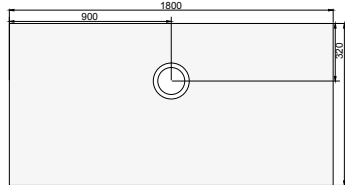

Size:	1800 x 900mm
Code:	QKIT8G1 ...G3
£ (Inc VAT):	783.60 823.20

Grill options

NB Kits with code G1 include a Solid Grill. Kits with code G3 include Stone Infill Grill.



Item:	Solid Grill
Code:	G1



Item:	Stone Infill Grill
Code:	G3

Tile inserted

For full details of waterproofing for timber floors see page 20-21.

* All of our wetroom products are covered by the Novellini Product Lifetime Guarantee. Our guarantee is valid only if used with Novellini products and does not cover installation.

Timber Floor - Waterproofing

A guide to Waterproofing your wetroom

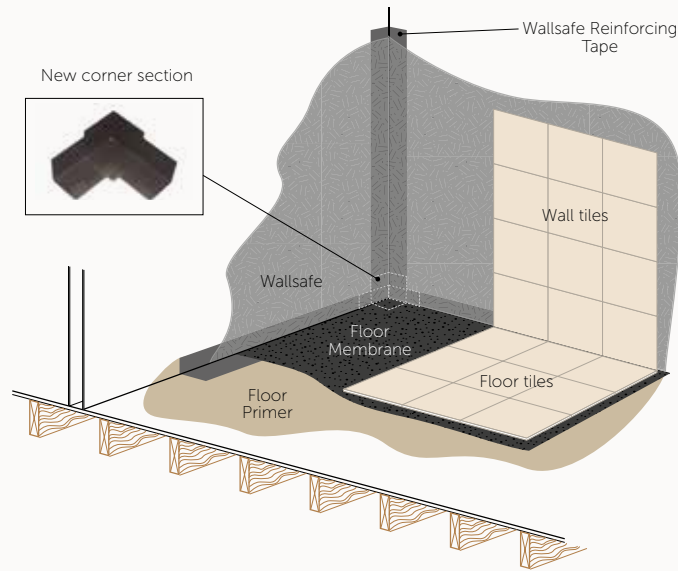

The importance of Waterproofing

The primary concern for anyone choosing to create a Wetroom is whether the floor or walls will either absorb, or worse let water through. Through our painstaking research and development we have created a system that is guaranteed, not just for a few years, but for life. The two components of this system are firstly the floor membrane and secondly the wall membrane, which are the key products for waterproofing the wetroom floor and walls.

We offer two self adhesive waterproof solutions for the floor membrane designed for use prior to the application of ceramic tiles and natural stone onto timber and solid floors in wetrooms:

- **Tilesure** is an evolution of our popular Tilesafe membrane which has been the professional's choice for over 15 years in both the commercial and domestic sectors. Developed specifically for use in bathrooms and wetrooms, Tilesure is comprised of a 1.4mm butyl based membrane with a copolymer top layer, which provides an excellent surface for the adhesion of natural stone, porcelain and ceramic tiles. Tilesure is quick and easy to apply, providing a consistent waterproof layer, guaranteed not to leak.

Tilesure also acts as a decoupling membrane by uncoupling the floor tiles and accommodating movement in the substrate, within a thickness of only 1.4mm. This omits the requirement for a traditional decoupling mat.

- **Floorsafe** – developed as a light weight, easy-fit, domestic product, is a cold-applied self-adhesive membrane which consists of a thin rubberised butyl waterproof layer with a fleece top surface.

For walls we recommend **Wallsafe**:

- A flexible single application paint-on waterproofing membrane, applied to the wall surfaces prior to the application of ceramic tiles and/or natural stone in wetrooms.

Application

For timber floors we recommend that either floor membrane, Tilesure or Floorsafe, is applied to the entire wetroom floor or at least to a distance of no less than 1 metre from the shower area. Wallsafe should then be applied to the walls of the shower area and overlapped onto the Reinforcing Tape.

2

Select Membrane Kit

Floor Membrane Kits

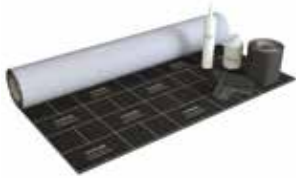

Tilesure 5m² Kit

500ml Primer, 10m Reinforcing Tape
5m x 1m Membrane
290ml Jointing Compound
4 x Pre-formed Corners

Floorsafe 5m² Kit

500ml Primer, 10m Reinforcing Tape
5m x 1m Membrane
290ml Jointing Compound
4 x Pre-formed Corners

Tilesure 10m² Kit

1ltr Primer, 15m Reinforcing Tape
10m x 1m Membrane
290ml Jointing Compound
4 x Pre-formed Corners

Floorsafe 10m² Kit

1ltr Primer, 15m Reinforcing tape
10m x 1m Membrane
290ml Jointing Compound
4 x Pre-formed Corners

Tilesure and Floorsafe are compatible with electric underfloor heating up to 150kw per m².



Choose from either Tilesure or Floorsafe kits:

Tilesure Kit offers the following features:

- Suitable for timber and solid floors
- Decouples up to 12mm
- Compatible with silicone sealants
- Self-adhesive - quick and easy to apply
- Ready to tile immediately

Floorsafe Kit offers the following features:

- Suitable for timber and solid floors
- Self-adhesive - quick and easy to apply
- Ready to tile immediately

ITEM	CODE	£ INC VAT
Tilesure 5m Kit	TSURE5	423.60
Tilesure 10m Kit	TSURE10	584.40
Floorsafe 5m Kit	BTMK5	361.20
Floorsafe 10m Kit	BTMK10	480.00

Additional Reinforcing Tape



**Tilesure
Reinforcing Tape**
10m roll



**Floorsafe
Reinforcing Tape**
10m roll

A self-adhesive reinforcing tape for use with the floor membrane. Choose either Tilesure or Floorsafe Tape, according to the Floor Membrane Kit selected. Reinforcing Tape is 125mm wide and suitable for all commonly encountered substrates.



ITEM	CODE	£ INC VAT
Tilesure Tape 10m	TAPEU10	93.60
Floorsafe Tape 10m	BTMTAPE10	70.80

Wall Membrane



**Wallsafe
Membrane**



**Wallsafe
Reinforcing Tape**

Wallsafe Membrane

- Quick and easy single coat application
- Compatible with Tilesure and Floorsafe
- Solvent free - covers up to 8m²
- Suitable for all commonly encountered substrates

Wallsafe Reinforcing Tape

- 75mm Wide x 10m
- Self-adhesive
- For use in corner wall junctions, vertical joints, soap recesses and other such detail

ITEM	CODE	£ INC VAT
Wallsafe Liquid 8kg	WSAFE8	117.60
Wallsafe Tape 75mm	WSAFET10	56.40



Concrete Floor - Guidelines

The Novellini wetroom for solid floors



Floor build-up

Our range of linear drains has been developed specifically for concrete or screeded floors and can be used on concrete slabs, planks and block and beam floors.

The key feature of the Linear Floor Drain is its height - the total height from the base to the top of the trough being **only 55mm** (see image below), making it perfect for today's modern construction methods.

The drain incorporates a unique 'waterless trap' which has a lifetime guarantee and has been granted BBA approval. For details see below.

Novellini Wetroom floor systems are suitable to be installed in combination with electric underfloor heating (max specification 150 watts/sq metre).

Typical solid floor build-up

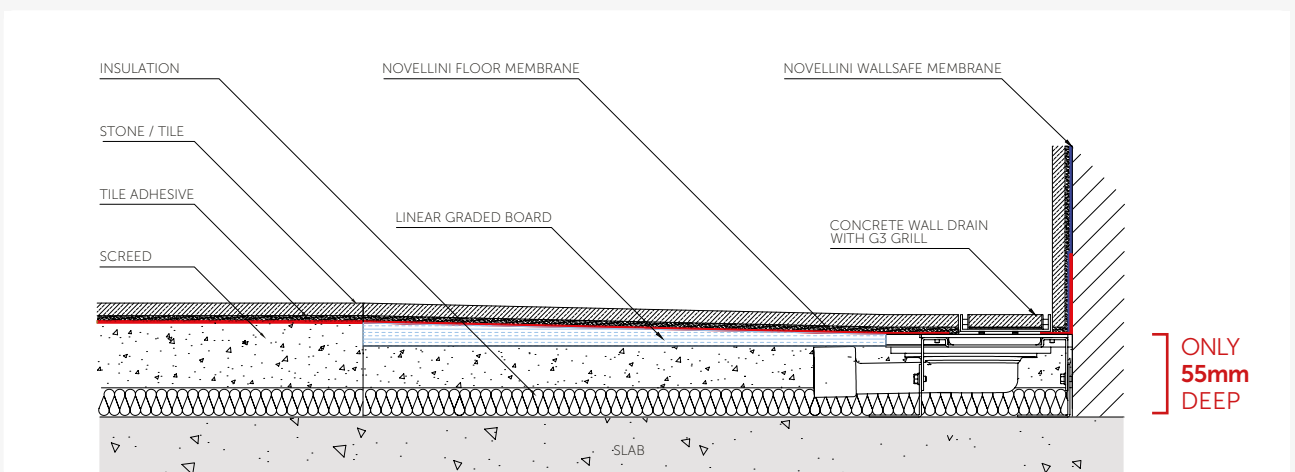

Waterless Trap

All drains are available with one or two traps and a choice of stylish grill finishes. The trap has been specially designed with a spring loaded mechanism which keeps the trap sealed when not in use. This ensures that even when left

unused for prolonged periods the trap cannot dry out, making it ideal for situations where the shower is not in everyday use. The smart design of the linear trough allows the waste position to be rotated through 360° enabling installation in most scenarios with ease.

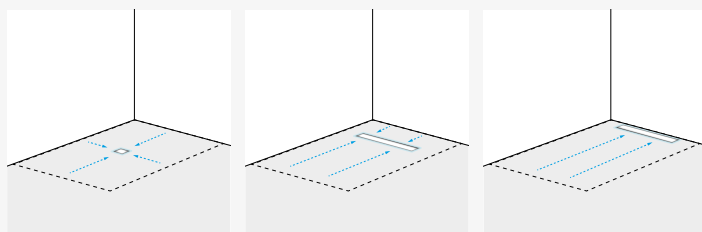

Four simple steps to order your Concrete Floor solution

Uno4 Drain
Linear Floor Drain
Linear Wall Drain

1 Drain and Grill

The gradient is formed within the screed, typically 12mm from the finished floor level to the drain.

All drains feature a multi-directional outlet for ease of installation.

Linear Drains are available with either Single or Double outlet depending on the flow rate required. Linear Drains are available in several lengths - see page 21 for details.

Choose either:

- Uno4 Drain - for a four-way fall
- Linear Floor Drain - for a two-way fall or
- Linear Wall Drain - for a one-way fall



2 Graded Board and Tile Trim

Use the Graded Board to provide a pre-formed consistent gradient towards the drain. For all Linear Drains it is important to order a trim detail to define the edge of the wetroom area.



Screedsure
Concrete Floor Membrane Kit

3 Floor Membrane Kit

It is essential to ensure your concrete floor wetroom is correctly waterproofed using a Screedsure Floor Membrane Kit.



Wallsafe Membrane



Wallsafe Reinforcing Tape



Additional Reinforcing Tape
Screedsure Reinforcing Tape

4 Wall Membrane & Reinforcing Tape

Use Wallsafe on the walls within and around the shower area. Use Reinforcing tape for sealing critical Wall-Wall and Wall-Floor joints.

Concrete Floor - Drain and Grill



Uno4 Drain - 4 way fall

Features of the Uno4 Drain

- Height adjustable drain body
- 360° Rotatable waste position
- Horizontal (height 138-255mm) & Vertical (height 55-88mm) trap options
- Flow rate up to 24 L/min
- Height adjustable grill
- Grill size 130mm x 130mm
- Lifetime Homes compatible

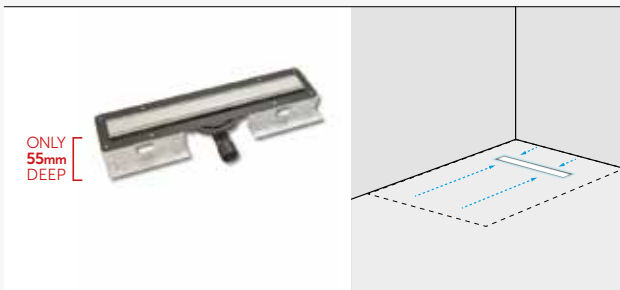

Linear Floor Drain - 2 way fall

Features of a Linear Floor Drain

- Height adjustable 55-88mm
- BBA approved
- Lifetime Guarantee
- 360° rotatable waste position
- Waterless trap
- Flow rate up to 50 L/min
- Height adjustable grill
- Easy to clean and replace trap
- Bespoke design available
- Grill width 86mm, grill lengths from 600 - 2000mm

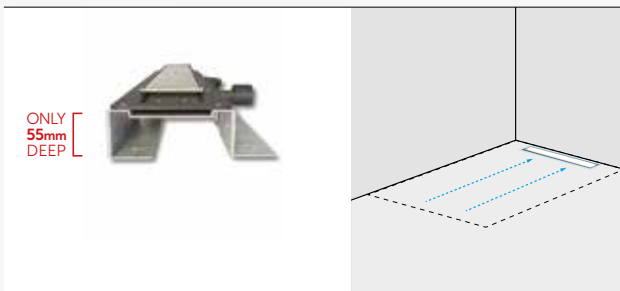

Linear Wall Drain - 1 way fall

Features of a Linear Wall Drain

- Height adjustable 55-88mm
- BBA approved
- Lifetime Guarantee
- 360° rotatable waste position
- Waterless trap
- Flow rate up to 50 L/min
- Height adjustable grill
- Easy to clean and replace trap
- Bespoke design available
- Grill width 86mm, grill lengths from 600 - 2000mm



Features of the Drain and Trap

- BBA approved
- 360° rotatable waste position
- Easy to clean and replace trap
- No requirement to top up the trap during long periods of non-use
- No siphoning of the trap due to other appliances
- No chance of smells or gases entering the room
- Available with one or two traps

1 Select Drain and Grill (see p26 for Linear Wall Drains)



Uno4 Drain



DESCRIPTION	GRILL SIZE	CODE	£ INC VAT
Single trap Uno4 Screed Drain, supplied with solid grill as standard. Maximum flow rate 24 L/min.	130 x 130 mm	UNO4HTG1*	309.60
	130 x 130 mm	UNO4HTG3*	382.80
	130 x 130 mm	UNO4VTG1*	309.60
	130 x 130 mm	UNO4VTG3*	382.80

*NB HT = Horizontal Trap, VT = Vertical Trap

Grill options NB Kits with code G1 include a Solid Grill. Kits with code G3 include Stone Infill Grill.



Item: Solid Grill
Code: G1



Item: Stone Infill
Code: G3
Tile inserted

Linear Floor Drain



DESCRIPTION	GRILL LENGTH	CODE SOLID GRILL	£ INC VAT	CODE INFILL GRILL	£ INC VAT
Single trap Linear Floor Drain, supplied with solid grill as standard. Maximum flow rate 29 L/min.	600 mm	CD60G1	458.40	CD60G3	530.40
	700 mm	CD70G1	470.40	CD70G3	544.80
	800 mm	CD80G1	506.40	CD80G3	578.40
	900 mm	CD90G1	514.80	CD90G3	586.80
	1000 mm	CD100G1	554.40	CD100G3	625.20
	1100 mm	CD110G1	574.80	CD110G3	645.60
	1200 mm	CD120G1	591.60	CD120G3	664.80
	1300 mm	CD130G1	603.60	CD130G3	675.60
	1400 mm	CD140G1	618.00	CD140G3	690.00
	1500 mm	CD150G1	633.60	CD150G3	704.40

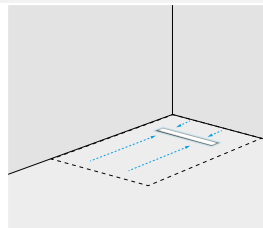

DESCRIPTION	GRILL LENGTH	CODE SOLID GRILL	£ INC VAT	CODE INFILL GRILL	£ INC VAT
Double trap Linear Floor Drain, supplied with solid grill as standard. Maximum flow rate 56 L/min.	600 mm	CDDT60G1	567.60	CDDT60G3	638.40
	700 mm	CDDT70G1	585.60	CDDT70G3	658.80
	800 mm	CDDT80G1	614.40	CDDT80G3	687.60
	900 mm	CDDT90G1	625.20	CDDT90G3	697.20
	1000 mm	CDDT100G1	662.40	CDDT100G3	733.20
	1100 mm	CDDT110G1	669.60	CDDT110G3	742.80
	1200 mm	CDDT120G1	692.40	CDDT120G3	765.60
	1300 mm	CDDT130G1	698.40	CDDT130G3	770.40
	1400 mm	CDDT140G1	714.00	CDDT140G3	786.00
	1500 mm	CDDT150G1	727.20	CDDT150G3	800.40

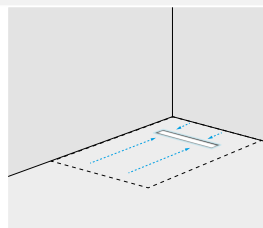

Please note:

- Additional standard lengths available: 1600, 1700, 1800, 1900, 2000mm.
- Bespoke lengths also available between 600 - 2000mm on request.
- Please allow 7 days for delivery.

For full details of waterproofing for concrete floors see page 28.

* All of our wetroom products are covered by the Novellini Product Lifetime Guarantee. Our guarantee is valid only if used with Novellini products and does not cover installation.

1

Select Drain and Grill



Linear Wall Drain

DESCRIPTION	GRILL LENGTH	CODE SOLID GRILL	£ INC VAT	CODE INFILL GRILL	£ INC VAT
Single trap Linear Wall Drain, supplied with solid grill as standard. Maximum flow rate 29 L/min	600 mm	CWD60G1	513.60	CWD60G3	585.60
	700 mm	CWD70G1	531.60	CWD70G3	604.80
	800 mm	CWD80G1	561.60	CWD80G3	633.60
	900 mm	CWD90G1	588.00	CWD90G3	660.00
	1000 mm	CWD100G1	608.40	CWD100G3	680.40
	1100 mm	CWD110G1	633.60	CWD110G3	704.40
	1200 mm	CWD120G1	670.80	CWD120G3	744.00
	1300 mm	CWD130G1	698.40	CWD130G3	770.40
	1400 mm	CWD140G1	714.00	CWD140G3	786.00
	1500 mm	CWD150G1	727.20	CWD150G3	800.40

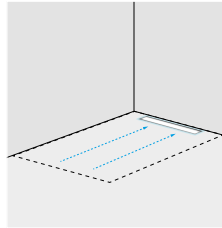

DESCRIPTION	GRILL LENGTH	CODE SOLID GRILL	£ INC VAT	CODE INFILL GRILL	£ INC VAT
Double trap Linear Wall Drain, supplied with solid grill as standard. Maximum flow rate 56 L/min	600 mm	CWDDT60G1	614.40	CWDDT60G3	687.60
	700 mm	CWDDT70G1	632.40	CWDDT70G3	705.60
	800 mm	CWDDT80G1	662.40	CWDDT80G3	733.20
	900 mm	CWDDT90G1	676.80	CWDDT90G3	748.80
	1000 mm	CWDDT100G1	709.20	CWDDT100G3	780.00
	1100 mm	CWDDT110G1	734.40	CWDDT110G3	806.40
	1200 mm	CWDDT120G1	754.80	CWDDT120G3	826.80
	1300 mm	CWDDT130G1	765.60	CWDDT130G3	836.40
	1400 mm	CWDDT140G1	780.00	CWDDT140G3	853.20
	1500 mm	CWDDT150G1	794.40	CWDDT150G3	866.40

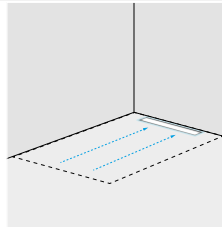
**Please note:**

- Additional standard lengths available: 1600, 1700, 1800, 1900, 2000mm.
- Bespoke lengths also available between 600 - 2000mm on request.
- Please allow 7 days for delivery.

Grill options **NB Kits with code G1 include a Solid Grill. Kits with code G3 include Stone Infill Grill.**



Item:	Solid Grill
Code:	G1
£ (Ex VAT):	Included in kit
£ (Inc VAT):	Included in kit



Item:	Stone Infill Grill
Code:	G3
£ (Ex VAT):	Included in kit
£ (Inc VAT):	Included in kit

Tile inserted



Linear Graded Board

Tile Strip:

These boards reduce installation time and guarantee the perfect gradient by using the slope of the board rather than screed to create the fall.

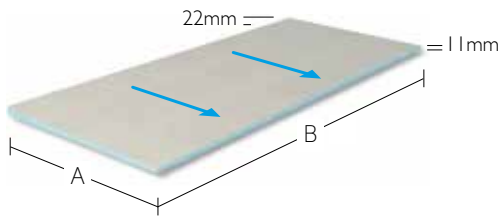

ITEM	CODE	DIMENSIONS (mm)		£ INC VAT
		A	B	
Board 1	LINGB300	300	1200	116.40
Board 2	LINGB500	500	1200	164.40
Board 3	LINGB700	700	1200	214.80
Board 4	LINGB800	800	1200	230.40
Board 5	LINGB900	900	1200	248.40
Board 6	LINGB1000	1000	1200	268.80
Board 7	LINGB1100	1100	1200	279.60
Board 8	LINGB1200	1200	1200	295.20
Board 9*	LINGB1500	1500	1200	367.20

*Supplied in two pieces

Infill Panel

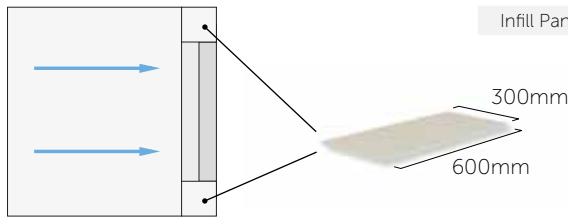

Infill Panel	LINIP1	300	600	26.40
--------------	--------	-----	-----	-------

Infill Panels are used for configurations where the width of the Linear Graded Board exceeds the width of the drain. Infill panels come in a standard 300 x 600mm format, but can be trimmed to suit your installation.

Linear Floor Drain Trim detail (Two-way fall)

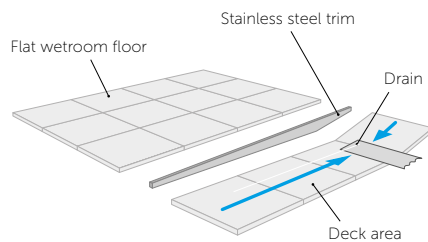

ITEM	CODE	DIMENSIONS	£ INC VAT
Tile strip 1	NWFSS1	300/600mm	55.20
Tile strip 2	NWFSS2	600/600mm	63.60
Tile strip 3	NWFSS3	300/900mm	63.60
Tile strip 4	NWFSS4	300/1200mm	78.00
Tile strip 5	NWFSS5	300/1500mm	87.60
Tile strip 6	NWFSS6	900/900mm	87.60
Tile strip 7	NWFSS7	300/700mm	63.60

Supplied separately, the trim provides a stylish stainless steel finish detailing the difference in tile heights where the sloping wetroom floor meets the flat wetroom floor.

Linear Wall Drain Trim detail (One-way fall)

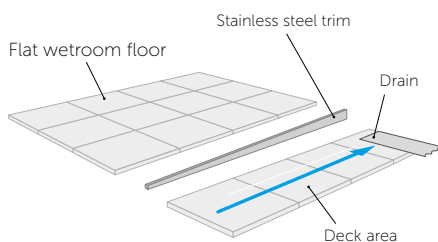

ITEM	CODE	DIMENSIONS	£ INC VAT
Tile strip 1	LINTT500	12 x 800mm	42.00
Tile strip 2	LINTT700	12 x 1000mm	52.80
Tile strip 3	LINTT800	12 x 1100mm	52.80
Tile strip 4	LINTT900	12 x 1200mm	52.80
Tile strip 5	LINTT1000	12 x 1300mm	63.60
Tile strip 6	LINTT1100	12 x 1400mm	63.60
Tile strip 7	LINTT1200	12 x 1500mm	63.60
Tile strip 8	LINTT1500	12 x 1800mm	63.60

For full details of waterproofing for concrete floors see page 28.

* All of our wetroom products are covered by the Novellini Product Lifetime Guarantee. Our guarantee is valid only if used with Novellini products and does not cover installation.

Concrete Floor - Waterproofing

A guide to Waterproofing your wetroom

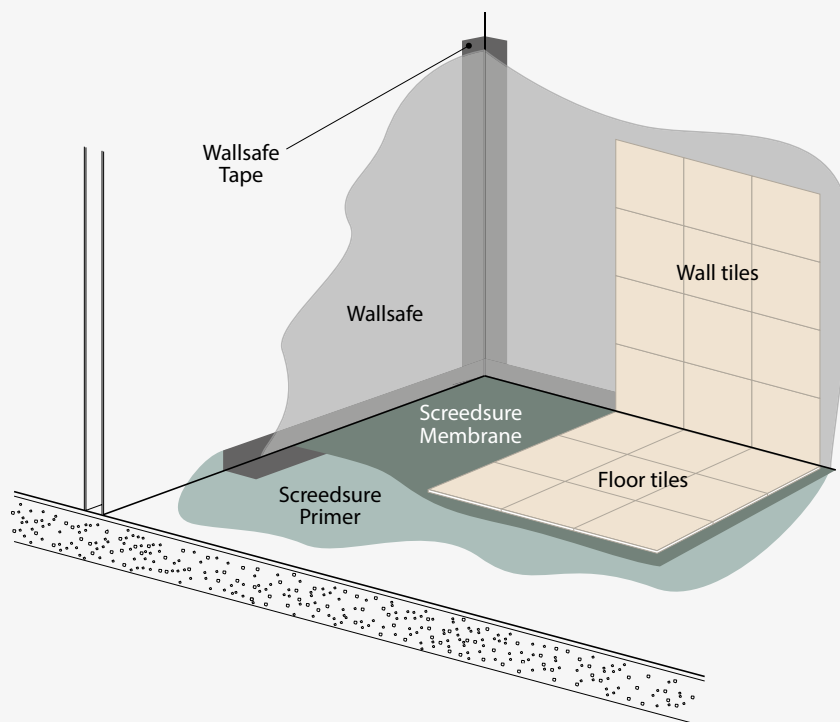

The importance of Waterproofing

The primary concern for anyone choosing to create a wetroom is whether the floor or walls will either absorb, or worse let water through.

Through our painstaking research and development we have created a system that is guaranteed, not just for a few years, but for life.

The two components of this system are Scredsure and Wallsafe - products for waterproofing the wetroom floor and walls.

Scredsure is a copolymer self-adhesive waterproofing membrane specifically designed for use onto screeded and other solid floors in wetrooms and bathrooms.

Scredsure is comprised of a 1mm butyl based membrane, with a fabric top layer, providing an excellent surface for the adhesion of natural stone, porcelain and ceramic tiles.

Scredsure is quick and easy to apply, providing a consistent waterproof layer, guaranteed not to leak.

For walls we recommend **Wallsafe**: A flexible single application paint-on waterproofing membrane, applied to the wall surfaces prior to the application of ceramic tiles and/or natural stone in wetrooms.

Application

For solid floors we recommend that the Scredsure membrane is applied to the shower area plus an additional one metre in either direction.

Wallsafe should then be applied to the walls of the shower area and overlapped onto the Reinforcing Tape.

3 Select Membrane Kit

4 Select Wall Membrane & Tape

Floor Membrane Kit



- Suitable for solid floors only
- Self-adhesive - quick and easy to apply
- Ready to tile immediately
- Ideal for fast track construction
- Supplied as a kit
- Factory controlled thickness
- Compatible with electric underfloor heating up to 150kw per m²

Scredsure 5m² Kit

500ml Primer, 10m Reinforcing tape, 5m x 1m Membrane, 290ml Jointing Compound
4 x Pre-formed corners

Scredsure 10m² Kit

1ltr Primer, 15m Reinforcing tape, 10m x 1m Membrane, 290ml Jointing Compound
4 x Pre-formed corners

ITEM	CODE	PRICE £ INC VAT
5m Roll + Ancillaries	SSURE5	367.20
10m Roll + Ancillaries	SSURE10	543.60

Additional Reinforcing Tape



A self-adhesive reinforcing tape for use with Scredsure. Reinforcing tape is 125mm wide.

Scredsure Reinforcing Tape

10m roll

ITEM	CODE	PRICE £ INC VAT
Scredsure Tape 10m	TAPEU10	93.60

Wall Membrane



**Wallsafe
Wall Membrane**



**Wallsafe
Reinforcing Tape**

Wallsafe Membrane

- Quick and easy single coat application
- Compatible with Tilesure and Floorsafe
- Solvent free - covers up to 8m²
- Suitable for all commonly encountered substrates

Wallsafe Reinforcing Tape

- 75mm wide x 10m
- Self-adhesive
- For use in corner wall junctions, vertical joints, soap recesses and other such detail

ITEM	CODE	£ INC VAT
Wallsafe Liquid 8kg	WSAFE8	117.60
Wallsafe Tape 75mm	WSAFET10	56.40

▶ Glass

Selecting your glass



Considerations when selecting Glass

Selecting your screen is a personal choice and with our range of thousands of combinations, we are confident we can provide a layout to suit your requirements.

From raw materials through to semi-processed goods and assembly of the various components, each manufacturing stage is carefully planned, monitored and tested to ensure the highest levels of quality required by a global market.

Easy to keep clean

Each glass panel is treated with 'crystal clear' treatment which reduces build up of limescale leaving the glass mark free.

Safety Glass

All our products are designed to meet the latest EU quality and safety standards.



Kuadra H & H2

Kuadra H - single screen



WIDTH CMS²	FRAME COLOUR	GLASS THICKNESS MM	SUPPORT WIDTH CMS²	PRODUCT CODE	PRICE £ INC VAT
30	CHROME	8	100	KUADH301K	393.60
30	BLACK	8	100	KUADH301H	393.60
40	CHROME	8	100	KUADH401K	393.60
40	BLACK	8	100	KUADH401H	393.60
50	CHROME	8	100	KUADH501K	466.80
50	BLACK	8	100	KUADH501H	466.80
60	CHROME	8	100	KUADH601K	466.80
60	BLACK	8	100	KUADH601H	466.80
70	CHROME	8	100	KUADH701K	536.40
70	BLACK	8	100	KUADH701H	536.40
75	CHROME	8	100	KUADH751K	536.40
75	BLACK	8	100	KUADH751H	536.40
80	CHROME	8	100	KUADH801K	609.60
80	BLACK	8	100	KUADH801H	609.60
90	CHROME	8	100	KUADH901K	609.60
90	BLACK	8	100	KUADH901H	609.60
100	CHROME	8	100	KUADH1001K	609.60
100	BLACK	8	100	KUADH1001H	609.60
110	CHROME	8	100	KUADH1101K	679.20
110	BLACK	8	100	KUADH1101H	679.20
120	CHROME	8	100	KUADH1201K	679.20
120	BLACK	8	100	KUADH1201H	679.20
130	CHROME	8	100	KUADH1301K	751.20
130	BLACK	8	100	KUADH1301H	751.20
140	CHROME	8	100	KUADH1401K	751.20
140	BLACK	8	100	KUADH1401H	751.20
150	CHROME	8	100	KUADH1501K	823.20
150	BLACK	8	100	KUADH1501H	823.20
160	CHROME	8	100	KUADH1601K	823.20
160	BLACK	8	100	KUADH1601H	823.20



Kuadra HFA - flipper panel only

WIDTH CMS²	FRAME COLOUR	GLASS THICKNESS MM	SUPPORT WIDTH CMS²	PRODUCT CODE	PRICE £ INC VAT
37	CHROME	8	N/A	KUADHA37-1K	140.40
37	BLACK	8	N/A	KUADHA37-1H	140.40

Kuadra H2 - screen with pivoting screen



WIDTH CMS²	FRAME COLOUR	GLASS THICKNESS MM	SUPPORT WIDTH CMS²	PRODUCT CODE	PRICE £ INC VAT
68 + 37	CHROME	8	100	KUADH2681K	642.00
78 + 37	CHROME	8	100	KUADH2781K	711.60
88 + 37	CHROME	8	100	KUADH2881K	711.60
98 + 37	CHROME	8	100	KUADH2981K	711.60

Notes for all Kuadra screens

1. The width of the screen allows for up to a 30mm variation in the wall.
2. All Kuadra screens are 200cm in height.

▶ Glass

Kuadra H Squares & Stripes



The impact of a bathroom in which strong shades of black are used is unequalled; this latest interior trend is inspired by the robust industrial look of yesteryear.

Black is a powerful, elegant and luxurious colour. It enhances shapes and emphasises contrasts. Black also radiates energy and vitality.

The glass options shown in this brochure are a suggestion, for our complete solution please visit: www.novellini.co.uk

Kuadra H Squares & Stripes

Kuadra H Squares

Create your enclosure by ordering two screens. Details and prices below are per screen.



Kuadra H Squares with optional evo bar

WIDTH CMS	HEIGHT CMS	GLASS THICKNESS	PRODUCT CODE	PRICE £ INC VAT
77-80	200	8	KUADH8081H	724.80
87-90	200	8	KUADH9081H	724.80
97-100	200	8	KUADH10081H	724.80
117-120	200	8	KUADH12081H	794.40
137-140	200	8	KUADH14081H	866.40
157-160	200	8	KUADH16081H	938.40

NB - Two screens must be ordered together to make a complete enclosure.

Kuadra H Stripes

Create your enclosure by ordering two screens. Details and prices below are per screen.



Kuadra H Stripes with optional evo bar

WIDTH CMS	HEIGHT CMS	GLASS THICKNESS	PRODUCT CODE	PRICE £ INC VAT
77-80	200	8	KUADH8082H	724.80
87-90	200	8	KUADH9082H	724.80
97-100	200	8	KUADH10082H	724.80
117-120	200	8	KUADH12082H	794.40
137-140	200	8	KUADH14082H	866.40
157-160	200	8	KUADH16082H	938.40

NB - Two screens must be ordered together to make a complete enclosure.

▶ Glass

Young - the complete enclosure for corner or alcove



Benefits of the Young range

Combining minimalist design with strength, Young enclosures exude style and quality with their low profile frame, robust door hinges and metal door handle for ease of operation. With no door thresholds they are particularly suitable for installation directly on to tiled floors making them perfect for wetroom installation.

Young doors open inwards as well as outwards, enabling you to fold the shower enclosure back when not in use - great for saving space in smaller wetrooms.

The glass options shown in this brochure are a suggestion, for our complete solution please visit: www.novellini.co.uk

Young

Young Corner - two doors, both hinged

Create your enclosure by ordering two sides. Details and prices below are per side.



WIDTH CMS ¹	HEIGHT CMS ²	GLASS THICKNESS ³	PRODUCT CODE	PRICE £ INC VAT
77-79	200	6	Y22G77L1K	488.40
79-81	200	6	Y22G79L1K	488.40
85-87	200	6	Y22G85L1K	488.40
87-89	200	6	Y22G87L1K	510.00
89-91	200	6	Y22G89L1K	510.00
95-97	200	6	Y22G95L1K	510.00
97-99	200	6	Y22G97L1K	531.60
99-101	200	6	Y22G99L1K	531.60

NB - LEFT and RIGHT hand screens must be ordered together to make a complete enclosure.

Young Corner - one hinged door, one fixed side panel

Create your enclosure by ordering one door (right hand or left hand side) and one fixed side panel.



WIDTH CMS ¹	HEIGHT CMS ²	GLASS THICKNESS ³	PRODUCT CODE	PRICE £ INC VAT
HINGED DOORS				
77-79	200	6	Y2G771K	488.40
79-81	200	6	Y2G791K	488.40
85-87	200	6	Y2G851K	488.40
87-89	200	6	Y2G871K	510.00
89-91	200	6	Y2G891K	510.00
95-97	200	6	Y2G951K	510.00
97-99	200	6	Y2G971K	531.60
99-101	200	6	Y2G991K	531.60
SIDE PANEL				
77-79	200	6	Y2FG771K	448.80
79-81	200	6	Y2FG791K	448.80
85-87	200	6	Y2FG851K	475.20
87-89	200	6	Y2FG871K	475.20
89-91	200	6	Y2FG891K	475.20
95-97	200	6	Y2FG951K	475.20
97-99	200	6	Y2FG971K	500.40
99-101	200	6	Y2FG991K	500.40

Notes for all Young screens

- All young screens are reversible or have left or right hand options.
 - All Young screens feature clear glass with Crystal Clear treatment and a chrome frame.
 - A 100cm horizontal support bar is included with the side panel. See page 31 for more options.
1. The width of the screen allows for up to a 40mm variation in the wall.
 2. The support bar, included in every pack, adds a further 1cm in height to the figures indicated.
 3. 6mm safety glass.

▶ Glass - Young

Young Alcove with single folding door



WIDTH CMS ¹	HEIGHT CMS ²	GLASS THICKNESS ³	PRODUCT CODE	PRICE £ INC VAT
72-76	195	6	Y21BS721K	705.60
77-81	195	6	Y21BS771K	732.00
82-86	195	6	Y21BS821K	758.40
87-91	195	6	Y21BS871K	758.40
94-98	195	6	Y21BS941K	786.00
97-101	195	6	Y21BS971K	786.00
107-111	195	6	Y21BS1071K	798.00
117-121	195	6	Y21BS1171K	812.40

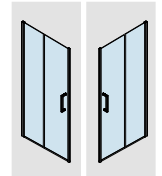

LEFT RIGHT

NB - Please state LEFT or RIGHT hand screen when ordering.

Young Alcove with single door and fixed inline panel



WIDTH CMS ¹	HEIGHT CMS ²	GLASS THICKNESS ³	PRODUCT CODE	PRICE £ INC VAT
97-101	195	6	Y2GFL971K	716.40
114-118	195	6	Y2GFL1141K	751.20
117-121	195	6	Y2GFL1171K	751.20
137-141	195	6	Y2GFL1371K	841.20
147-151	195	6	Y2GFL1471K	864.00
157-161	195	6	Y2GFL1571K	889.20
167-171	195	6	Y2GFL1671K	903.60
177-181	195	6	Y2GFL1771K	914.40

Young Corner with two hinged and folding doors

Create your enclosure by ordering two sides. Details and prices below are per side.



WIDTH CMS ¹	HEIGHT CMS ²	GLASS THICKNESS ³	PRODUCT CODE	PRICE £ INC VAT
77-79	200	6	Y22GS77L1K	554.40
79-81	200	6	Y22GS79L1K	579.60
85-87	200	6	Y22GS85L1K	579.60
87-89	200	6	Y22GS87L1K	579.60
89-91	200	6	Y22GS89L1K	579.60
95-97	200	6	Y22GS95L1K	603.60
97-99	200	6	Y22GS97L1K	603.60
99-101	200	6	Y22GS99L1K	603.60
115-117	200	6	Y22GS115L1K	603.60
117-119	200	6	Y22GS117L1K	628.80

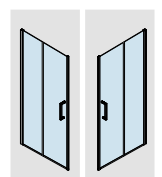

LEFT RIGHT

NB - LEFT and RIGHT hand screens must be ordered together to make a complete enclosure.

Additional products



Evo Fixing System - Corner Version

(Supplied with 2 clamps and a corner piece)

FRONT BAR MAX WIDTH (cms)	SIDE BAR MAX WIDTH (cms)	PRODUCT CODE	COLOUR	PRICE £ INC VAT
180	120	KUADHSFB	SILVER	226.80
180	120	KUADHSFK	CHROME	226.80



Evo Fixing System - Recess Version

FRONT BAR MAX WIDTH (cms)	SIDE BAR MAX WIDTH (cms)	PRODUCT CODE	COLOUR	PRICE £ INC VAT
180	120	KUADHSFNB	SILVER	162.00
180	120	KUADHSFNK	CHROME	162.00



Optional corner support for Kuadra and Young

WIDTH (cms)	PRODUCT CODE	PRICE £ INC VAT
25	R80LOU250K	69.60
35	R80LOU350K	75.60
45	R80LOU450K	81.60



Optional long support bar for Kuadra only

COLOUR	WIDTH (cms)	PRODUCT CODE	PRICE £ INC VAT
CHROME	150	R80GIANF15K	96.00



Optional ceiling kit for Kuadra only

(to be used with supplied support bar)

COLOUR	PRODUCT CODE	PRICE £ INC VAT
CHROME	R801SOFELK	43.20



Chrome Aluminium bottom profile for 6/8mm glass

PROFILE LENGTH	PRODUCT CODE	PRICE £ INC VAT
100cm	P51BOHU10K	36.00
150cm	P51BOHU15K	44.40

► Inspiration

New ideas - further details on novellini.co.uk



Inspiration

If you are looking for something a little more creative from your bath or shower room then we have something special to inspire you.

Investment in in-Art HD glass printing technology has enabled us to create our latest range of contemporary shower screens.

These designs allow you to create a feature wetroom that is way beyond ordinary.

In addition to the shower screens we also produce our own bathroom furniture. By selecting from our Divina Bath range and lotti furniture you can complete the look for your bespoke bath or shower room.



The image above features baths from our Divina range.

All furniture is courtesy of our Lotti collection and the shower head and controls are 'Easy Shower'. The glass is Kuadra H with Black Edging.

The two glass options below show our creative flair with the Kuadra H 'Grid' to the left and Kuadra H 'Wires' to the right.

For more details please visit novellini.co.uk



UK Head Office
Novellini UK Ltd
Unit 11
Caxton Court
Porters Wood
St Albans
Hertfordshire
AL3 6XT

e: info-uk@novellini.com

t: 01727 229922

f: 01727 838232

wetrooms.novellini.com

wetroom technical support: 01256 766757

