

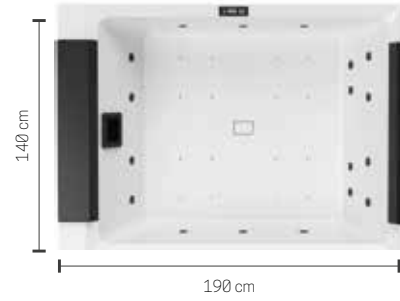















DIVINA M 190x140



Dimensions cm	190 x 140 H 75
Seats	
Capacity Lt.	550
Absorption Max Watt	2400
Max. weight kg	960

FUNCTIONS	BASIC	STANDARD	PLUS	PLUS+ NATURAL AIR
 Whirlpool jets	14	18	18	18
 Whirlpool mini jets	-	-	16	16
 Natural Air	-	-	-	2
 UV purification system	OPTIONAL	OPTIONAL	OPTIONAL	OPTIONAL
 White LED light	2	4	4	4
 Chromolight	-	OPTIONAL	OPTIONAL	OPTIONAL
 Headrest	-	●	●	●
 Bluetooth audio system	-	OPTIONAL	OPTIONAL	OPTIONAL
 Wi-Fi module	OPTIONAL	OPTIONAL	OPTIONAL	OPTIONAL
 Double speed pump	●	●	●	●
 Skimmer water filter	●	●	●	●
 Heater 2 kW	●	●	●	●
 Heat exchanger	OPTIONAL	OPTIONAL	OPTIONAL	OPTIONAL
 Automatic refill	OPTIONAL	OPTIONAL	OPTIONAL	OPTIONAL
 Fast emptying/filling + level control	OPTIONAL	OPTIONAL	OPTIONAL	OPTIONAL

BATHTUB COLOUR

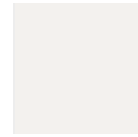

A0 White

PANELS / SEAT AND HEADREST FIBER-CROSS



T1 Light grey T2 Warm brown T3 Steel

CLAY PANELS

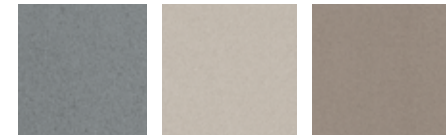

R Cenere O Polvere S Tortora

NATURAL TOUCH PANELS



P1 Oak Alpine P2 Oak Concrete P3 Oxid P4 Quarz

SLATTED PANELS



D1 Dark brown D2 Ice

THERMAL COVER



C2 Brown C1 Plenty Grey

DIVINA M BASIC

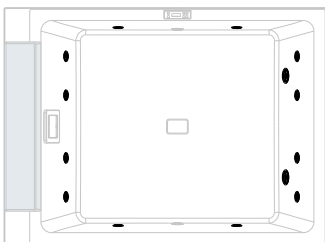

DIVINA M STANDARD

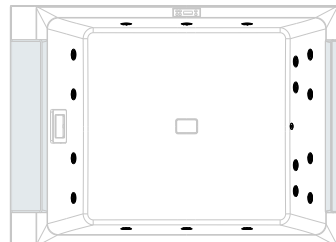

DIVINA M PLUS

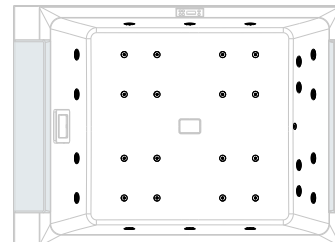

DIVINA M PLUS+NATURAL AIR

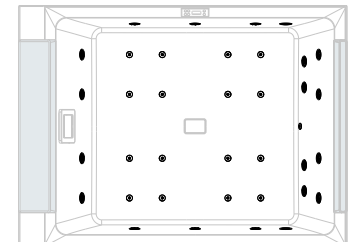

Code	Functions				Level control options			Bathtub Colour	Headrest/Side Seat Colour			
	White LED	UV + LED white	Chromolight + audio BT	UV + Chromolight + audio BT	None	Automatic refill	Fast emptying/ filling + level control	Shiny white	Black	Light Grey	Warm Brown	Steel
BASIC												
	0X	3X	6X	4X	0	1	2	-A0	H	T1	T2	T3
DOM60												
STANDARD												
	0X	3X	6X	4X	0	1	2	-A0	H	T1	T2	T3
DOM50												
STANDARD WITH HEAT EXCHANGER												
	0R	3R	6R	4R	0	1	2	-A0	H	T1	T2	T3
DOM50												
PLUS												
	0X	3X	6X	4X	0	1	2	-A0	H	T1	T2	T3
DOM40												
PLUS WITH HEAT EXCHANGER												
	0R	3R	6R	4R	0	1	2	-A0	H	T1	T2	T3
DOM40												
PLUS+NATURAL AIR												
	0X	3X	6X	4X	0	1	2	-A0	H	T1	T2	T3
DOMPO												
PLUS+NATURAL AIR CON SCAMBIATORE DI CALORE												
	0R	3R	6R	4R	0	1	2	-A0	H	T1	T2	T3
DOMPO												

PANELS

Code	Panels finishes			
NATURAL TOUCH				
	P1	P2	P3	P4
	Oak-Alpine	Oak-Concrete	Oxid	Quarz
PANV2F2LDIVDO-				
ARGILLA				
	R	O	S	
	Cenere	Polvere	Tortora	
PANV2F2LDIVDO-				
SLATTED PANELS				
	D1	D2		
	Dark Brown	Ice		
PADV2F2LDIVDO-				
FIBER-CROSS				
	T1	T2	T3	
	Light Grey	Warm Brown	Steel	
PATV2F2LDIVDO-				

OPTIONAL

WI-FI MODULE

Code	Price
DOMOWF	

HEAT PUMP PREDISPOSITION KIT

Code	Price
DOKPDC	

INSULATION KIT

Insulation	Code	Price
Panels	KBT2F2LDOM	
Bathtub bottom	DOTHCOFV	

THERMAL COVER

Cover	Code	Price	
		C1	C2
Summer cover	DOTHCO-	Plenty Grey	Brown
Winter cover	DOTHCOT-		

Code composition

Codice

+

Functions

+

Level control options

+

Bathtub Colour

+

Headrest/Side Seat Colour

TECHNICAL DATA

DIVINA M

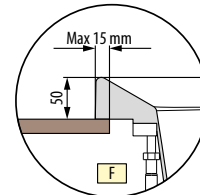
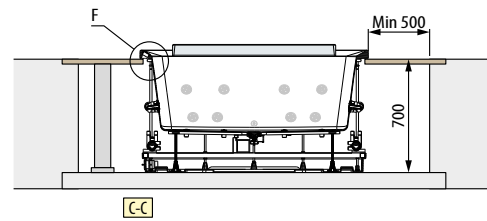
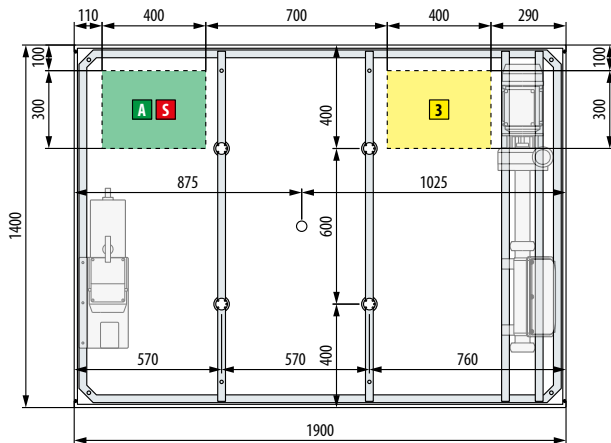
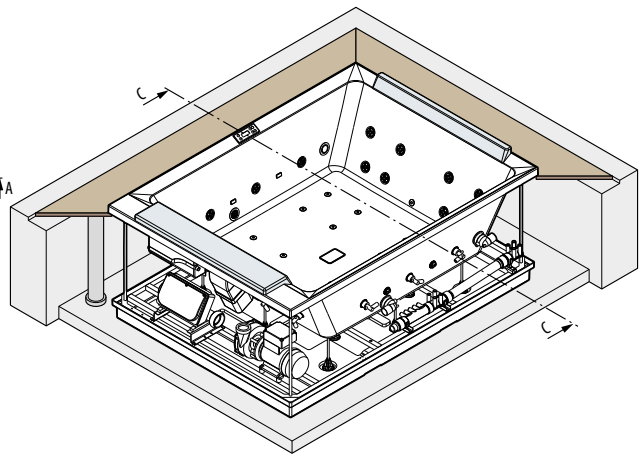
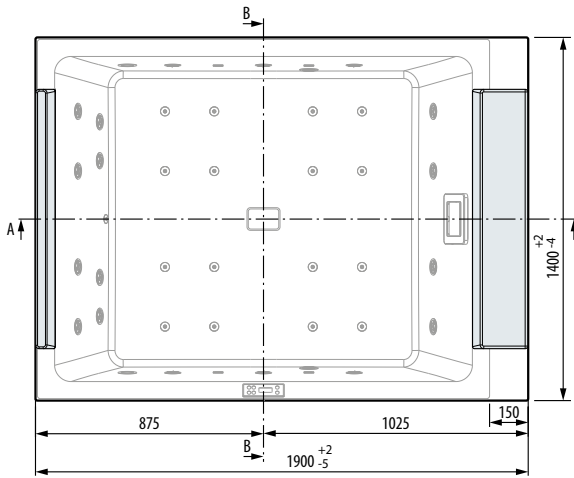
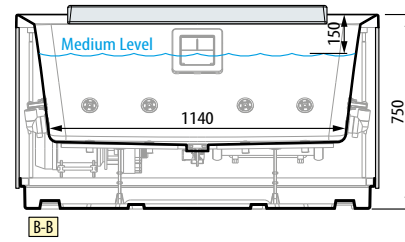
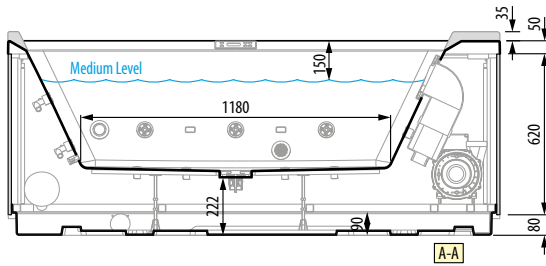

HYDRAULIC SPECIFICATIONS

Maximum capacity 550 litres
 18 side whirlpool jets
 16 mini jets on the bottom
 2 Natural Air jets

ELECTRICAL SPECIFICATIONS

Power 230 V
 Frequency 50 Hz
 Max heat absorption heater +
 low-speed pump: 2400 W

MECHANICAL CHARACTERISTICS

Total area 2.66 m²
 Total weight: 960 kg
 Bathtub+components mass 250 kg
 Users mass (2 pers.) 80+80 kg
 Specific load on support base 3610 N/m²