



VERSIONE BIANCO CON PANNELLI DOGATI ICE



VERSIONE BIANCO CON PANNELLI OAK CONCRETE

## VITA L | FINITURE

### VASCA

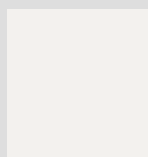

Bianco

### POGGIATESTA

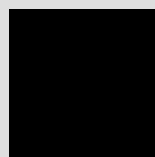

Nero

### PANNELLI NATURAL TOUCH

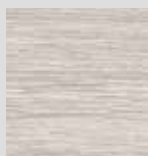

Oak Alpine



Oak Concrete

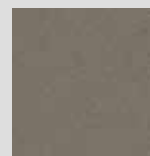

Oxid

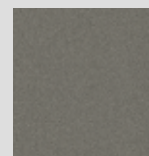

Quarz

### PANNELLI DOGATI

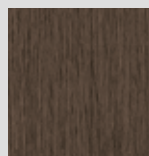

Dark brown

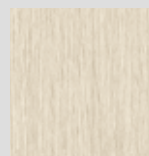

Ice



**Massaggio corpo Whirlpool** aria/acqua con regolazione di tempo e intensità manuale o automatica. Per soddisfare qualsiasi esigenza di benessere.



**Skimmer filtro acqua**



**Cromolight** con 8 variazioni cromatiche per attivare la mente ed emozionare lo spirito.



**Pannello di controllo**



**Poggiatesta** in materiale antibatterico.



**Diffusori audio bluetooth**  
2 interni e 2 esterni





VERSIONE BIANCO CON PANNELLI OAK ALPINE



Pannello di controllo



Sistema cromolight e audio Bluetooth



Posizionamento Jet incassato nello schienale



Vasca 3 posti



# VITAL

# VITA L

MINIPISCINA MULTIFUNZIONE 180x140x85 - 580 litri

Dimensioni cm 180 x 140 H 85





Posti 3

Capacità Lt. 580





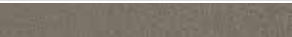

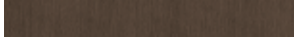
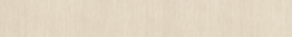





Codice	Scelta funzioni/Prezzo		Scelta riempimento		Colori Vasca	Colori sedile e poggiatesta
	UV + Cromolight	UV + Cromolight + audio Bluetooth	SENZA Reintegro Automatico	CON Reintegro Automatico		
					Bianco	Nero
<b>STANDARD</b>						
	<b>3X</b>	<b>4X</b>	<b>0</b>	<b>1</b>	<b>-W10</b>	<b>H</b>
<b>VITL50</b>						-
<b>STANDARD CON SCAMBIATORE DI CALORE</b>						
	<b>3R</b>	<b>4R</b>	<b>0</b>	<b>1</b>	<b>-W10</b>	<b>H</b>
<b>VITL50</b>						-
<b>PLUS</b>						
	<b>3X</b>	<b>4X</b>	<b>0</b>	<b>1</b>	<b>-W10</b>	<b>H</b>
<b>VITL40</b>						
<b>PLUS CON SCAMBIATORE DI CALORE</b>						
	<b>3R</b>	<b>4R</b>	<b>0</b>	<b>1</b>	<b>-W10</b>	<b>H</b>
<b>VITL40</b>						

Costruzione del codice **Codice** + **Scelta funzioni** + **Scelta riempimento** + **Colore vasca** + **Colore seduta poggiatesta** = Codice prodotto finale

## PANNELLI

Codice	Scelta finitura pannelli/prezzo			
<b>PANNELLI NATURAL TOUCH</b>				
	<b>P1</b>	<b>P2</b>	<b>P3</b>	<b>P4</b>
				
	Oak-Alpine	Oak-Concrete	Oxid	Quarz
<b>PANV2F2LVITL-</b>				
<b>PANNELLI DOGATI</b>				
	<b>D1</b>	<b>D2</b>		
				
	Dark Brown	Ice		
<b>PADV2F2LVITL-</b>				



FUNZIONI	STANDARD	PLUS
 whirlpool mini jets	4	6
 whirlpool jets	12	17
 Regolazione aria	-	1
 Chromolight	●	●
 Poggiatesta	-	●
 Sistema audio stereo + bluetooth	OPTIONAL	OPTIONAL
 Modulo Wi-Fi	OPTIONAL	OPTIONAL
 Sistema di purificazione UV	●	●
 Pompa a doppia velocità	●	●
 Riscaldatore 2 kW	●	●
 Scambiatore di calore	OPTIONAL	OPTIONAL
 Reintegro automatico	OPTIONAL	OPTIONAL

MODULO WI-FI	
Codice	Prezzo
<b>DOMOWF</b>	

KIT COIBENTAZIONE FONDO VASCA	
Codice	Prezzo
<b>VLTHCOFV</b>	

KIT COIBENTAZIONE PANNELLI		
Coibentazione	Codice	Prezzo
KIT OPZIONALE PER CLIMI RIGIDI	<b>KBT2F2LVIL</b>	

COPERTURA TERMICA		
Coibentazione	Codice	Prezzo
Copertura Estiva	<b>VLTHCO-C2</b>	
Copertura Invernale	<b>VLTHCOT-C2</b>	

TELO DI PROTEZIONE	
Codice	Prezzo
<b>VLCOPR</b>	

VERSIONE **STANDARD**

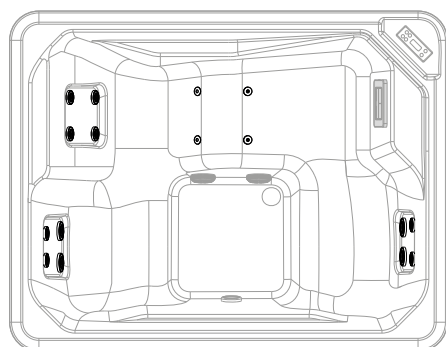

VERSIONE **PLUS**

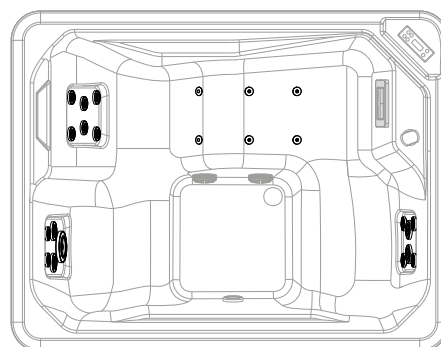

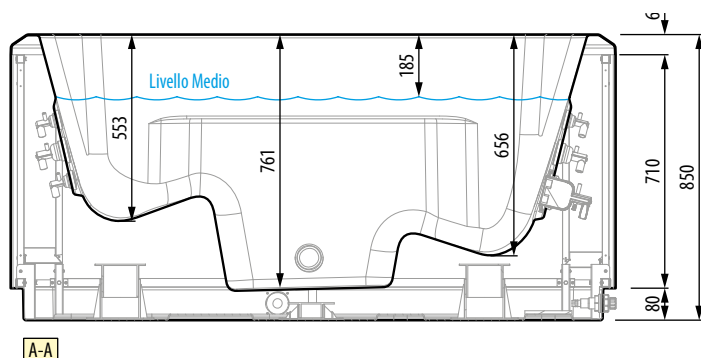

A-A

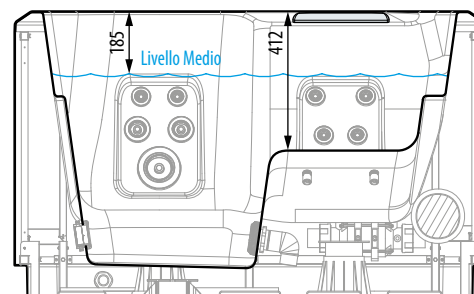

B-B

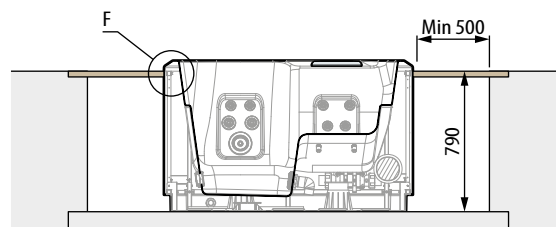
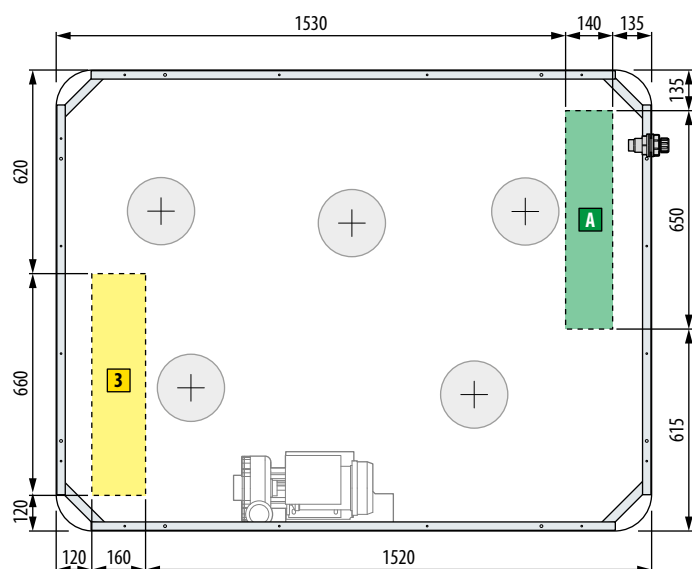
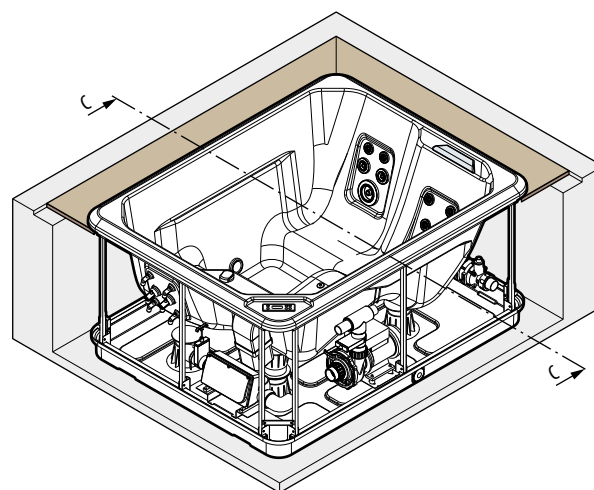
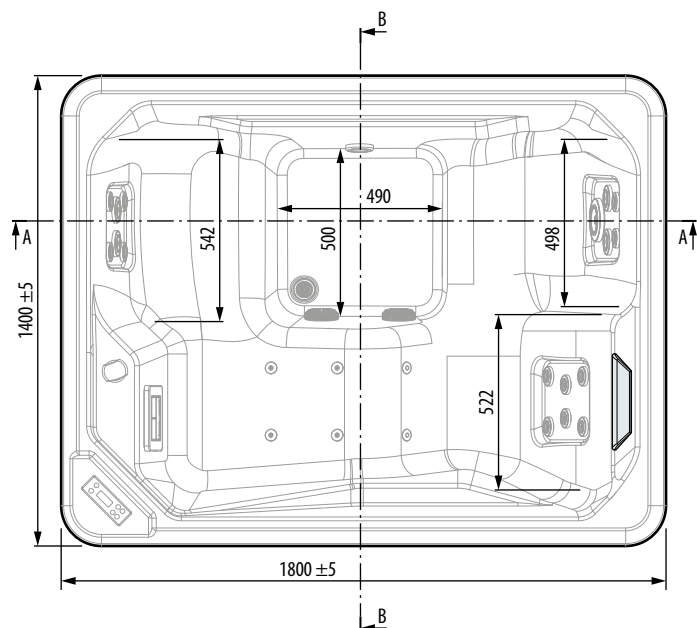

C-C

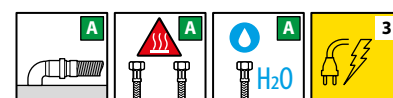
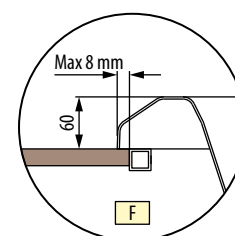

**CARATTERISTICHE IDRAULICHE**

capienza media 580 lt  
 17 bocchette whirlpool (12 versione standard)  
 6 bocchette mini jet (4 versione standard)

**CARATTERISTICHE ELETTRICHE**

Tensione 230 V  
 Frequenza 50 Hz  
 Potenza max richiesta 2400 W

**CARATTERISTICHE MECCANICHE**

Area totale 2,5 m<sup>2</sup>  
 Peso totale: 1100 kg  
 Peso vasca+componenti 280 kg  
 Peso utilizzatori (3 pers.) 80x3=240 kg  
 Carico specifico su base di appoggio 4350 N/m<sup>2</sup>