

# GLAX 2 2.0 R



**CABINA MULTIFUNZIONE SEMICIRCOLARE, APERTURA 2 ANTE SCORREVOLI E 2 FISSE**

Design Marco Pellici

Misure				Codice	Miscelatore		Vetro	Scelta finitura				
Dimensioni (cm)	Piatto doccia (cm)	Altezza totale (cm)	Entrata (cm)		M	T	1	UH	UU	HU	BB	TU
		<b>C</b>	*		Meccanico	Termostatico	Trasparente	Bianco	Total White	Nero	Silver	Corda
<b>HYDRO</b>												
					<b>M1-</b>	<b>T1-</b>	<b>1</b>	<b>UH</b>	<b>UU</b>	<b>HU</b>	<b>BB</b>	<b>TU</b>
90 X 90	4,5	217	49	<b>G22R90</b>								
90 X 90	11,5	224	49	<b>G22R99</b>								
100 X 100	4,5	217	49	<b>G22R100</b>								
100 X 100	11,5	224	49	<b>G22R109</b>								
<b>HYDRO PLUS</b>												
					<b>M1L-</b>	<b>T1L-</b>	<b>1</b>	<b>UH</b>	<b>UU</b>	<b>HU</b>	<b>BB</b>	<b>TU</b>
90 X 90	4,5	217	49	<b>G22R90</b>								
90 X 90	11,5	224	49	<b>G22R99</b>								
100 X 100	4,5	217	49	<b>G22R100</b>								
100 X 100	11,5	224	49	<b>G22R109</b>								
<b>HAMMAM</b>												
					<b>M5-</b>	<b>T5-</b>	<b>1</b>	<b>UH</b>	<b>UU</b>	<b>HU</b>	<b>BB</b>	<b>TU</b>
90 X 90	4,5	217	49	<b>G22R90</b>								
90 X 90	11,5	224	49	<b>G22R99</b>								
100 X 100	4,5	217	49	<b>G22R100</b>								
100 X 100	11,5	224	49	<b>G22R109</b>								



GLAX 2 2.0

GLAX 2 2.0 R SILVER

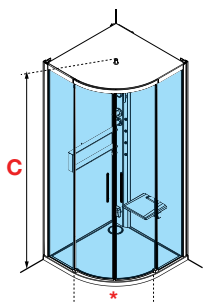



WHITE



TOTAL WHITE



BLACK



SILVER



CORDA

## GLAX 2 2.0 | FINITURE

	PROFILI	MANIGLIA	COLONNA + MENSOLA	PARETI FONDO	PIATTO	CUPOLINO *	SEDILE *
<b>WHITE</b>	Nero opaco	Nero opaco	Bianco opaco	Nero	Bianco opaco	Bianco opaco	Bianco
<b>TOTAL WHITE</b>	Bianco opaco	Bianco opaco	Bianco opaco	Bianco	Bianco opaco	Bianco opaco	Bianco
<b>BLACK</b>	Bianco opaco	Bianco opaco	Nero opaco	Bianco	Nero goffrato	Nero opaco	Bianco
<b>SILVER</b>	Silver	Cromo	Silver	Bianco	Bianco lucido	Bianco opaco	Bianco
<b>CORDA</b>	Bianco opaco	Bianco opaco	Corda	Bianco	Corda	Corda	Bianco

\* disponibili a seconda dell'allestimento

## GLAX 2 2.0 | FUNZIONI E DOTAZIONI (disponibili a seconda dell'allestimento)



Miscelatore meccanico o termostatico e doccia a mano con flessibile orientabile

Tettuccio con soffione doccia

Sistema di idromassaggio verticale

Ripiani d'appoggio

Bluetooth

Sedile reclinabile

Pannello di controllo elettronico soft-touch

Cromolight (versione hammam+hydro plus)  
Luce led (versione hydro)

HAMMAM (Sauna di vapore + erogatore di vapore con dispenser di aromi)

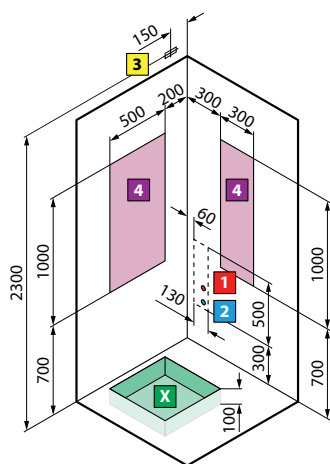
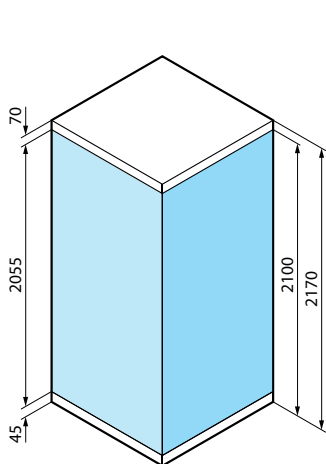

per modelli  
**A80 - A90 - A100 - GF80 - GF90 - R90 - R100**

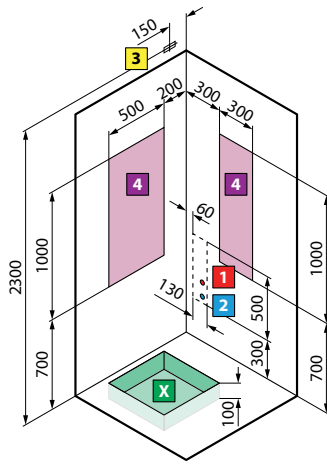

versione **destra**

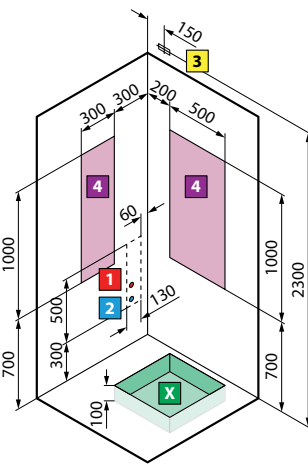

versione **sinistra**  
per mod. **A90x70 - A100x70 - A100x80 - 2P 120x80 - 2P 120x90**

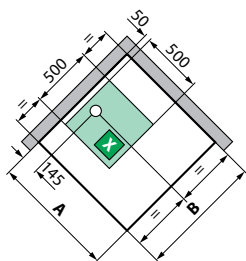

modello	A ± 3	B ± 3
<b>A80</b>	796	796
<b>A90</b>	896	896
<b>A 100</b>	996	996
<b>GF80</b>	796	796
<b>GF90</b>	896	896

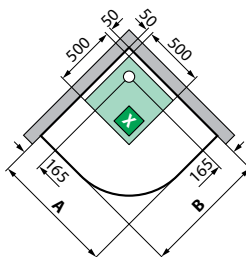

modello	A ± 3	B ± 3
<b>R90</b>	896	896
<b>R100</b>	996	996

### S INSTALLAZIONE A SINISTRA

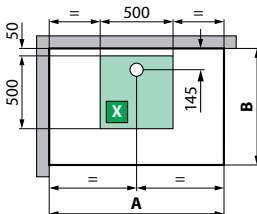

### D INSTALLAZIONE A DESTRA

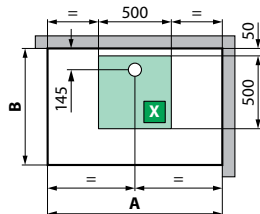

modello	A ± 3	B ± 3
<b>A90x70</b>	896	696
<b>A100x70</b>	996	696
<b>A100x80</b>	996	796
<b>2P120x80</b>	1196	796
<b>2P120x90</b>	1196	896

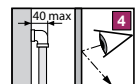
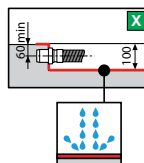
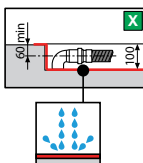

**ATTENZIONE!**  
Può essere dannoso ai portatori di pacemakers

Non ispezionabile

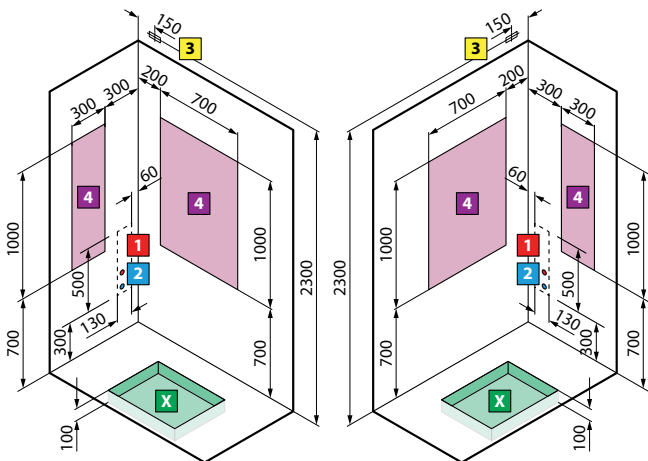

versione **sinistra**

versione **destra**

per mod. **2P140x80 - 2P140x90**

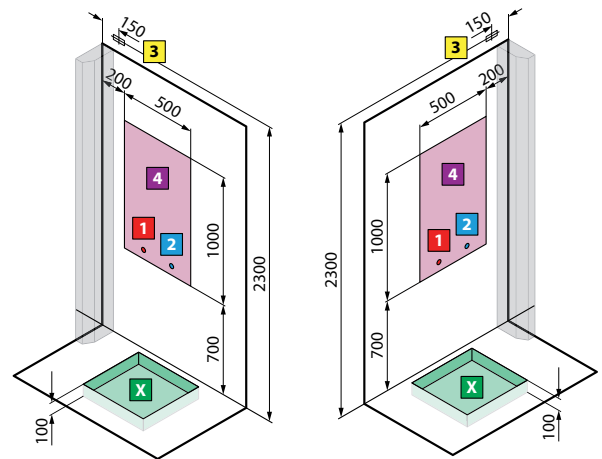

versione **sinistra**

versione **destra**

per mod. **A100x80**

per mod. **A100x80 - 2P120x80**

### S INSTALLAZIONE A SINISTRA

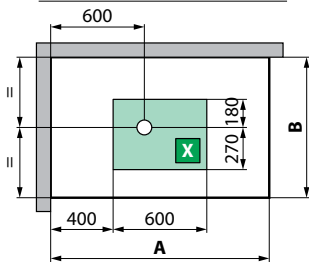

### D INSTALLAZIONE A DESTRA

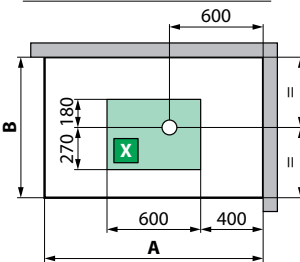

modello	A ± 3	B ± 3
<b>2P140x80</b>	1394	794
<b>2P140x90</b>	1394	894

### S INSTALLAZIONE A SINISTRA

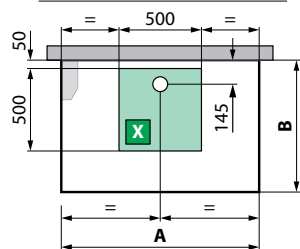

### D INSTALLAZIONE A DESTRA

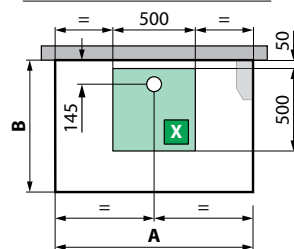

modello	A ± 3	B ± 3
<b>A+F100x80</b>	996	796
<b>2P+2F120x80</b>	1196	796

### CARATTERISTICHE IDRAULICHE:

Pressione dinamica ottimale 2÷5 bar  
 Acqua calda 1/2"  
 Acqua fredda 1/2"  
 Allaccio sifone con raccordo  $\varnothing$  40 mm

### CARATTERISTICHE ELETTRICHE:

Tensione 220 - 230 V  
 Frequenza 50/60 Hz  
 Potenza massima assorbita: 2600 W  
 Potenza nominale: 2500 W

**ATTENZIONE!** Installare a monte dell'apparecchio un interruttore differenziale da 30mA provvisto di interruttore onnipolare con apertura minima dei contatti  $\geq$  3 mm.

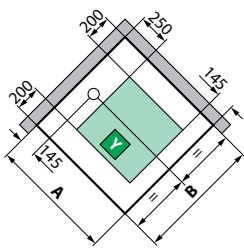
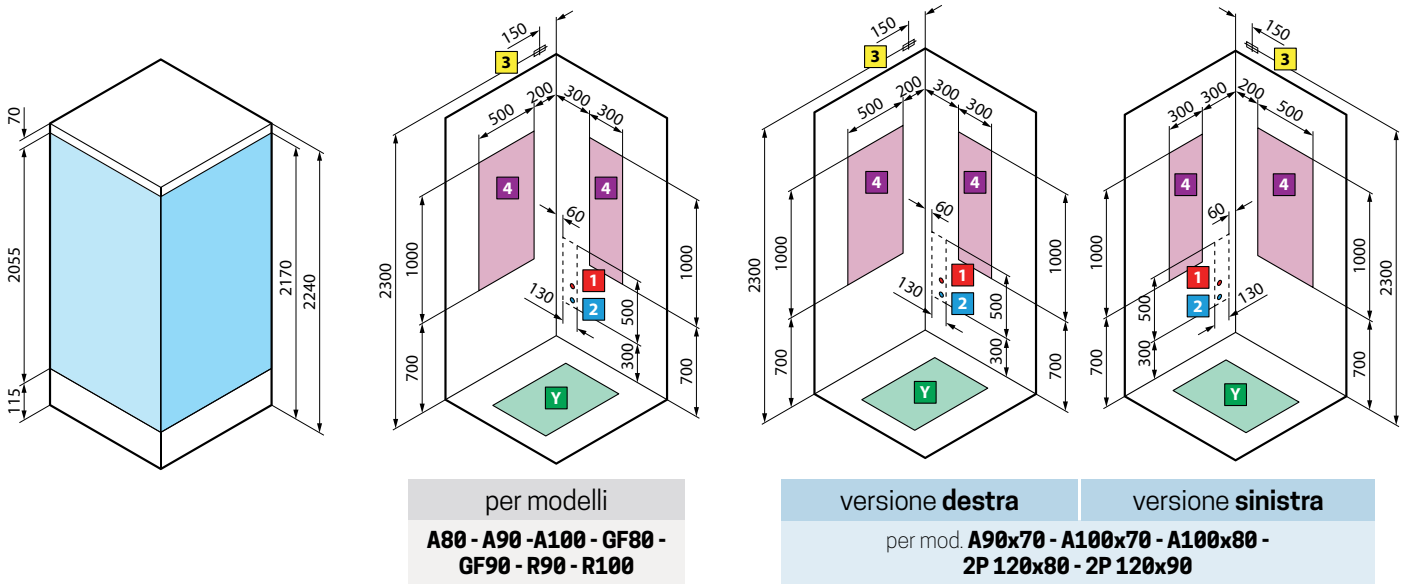

modello	A ± 4	B ± 4
<b>A80</b>	798	798
<b>A90</b>	898	898
<b>A 100</b>	998	998
<b>GF80</b>	798	798
<b>GF90</b>	898	898

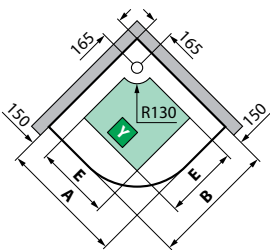

modello	A ± 4	B ± 4	E
<b>R90</b>	898	898	500
<b>R100</b>	998	998	600

### S INSTALLAZIONE A SINISTRA

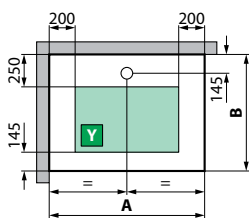

### D INSTALLAZIONE A DESTRA

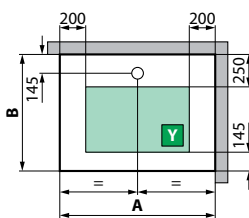

modello	A ± 4	B ± 4
<b>A90x70</b>	898	698
<b>A100x70</b>	998	698
<b>A100x80</b>	998	798
<b>2P120x80</b>	1198	798
<b>2P120x90</b>	1198	898

1

2

3

±10 mm

**ATTENZIONE!**  
Può essere dannoso ai portatori di pacemakers

Non ispezionabile

# GLAX 2.0 PIATTO 125

# DISEGNI TECNICI

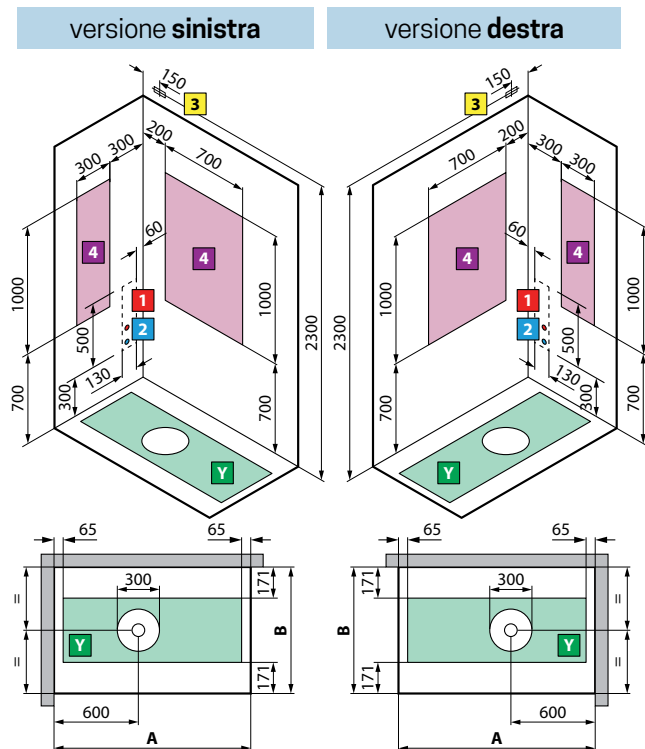
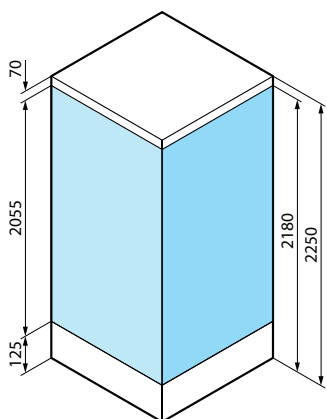

modello	A ± 3	B ± 3
<b>2P140x80</b>	1398	798
<b>2P140x90</b>	1398	898

# GLAX 2.0 PIATTO 115

# DISEGNI TECNICI

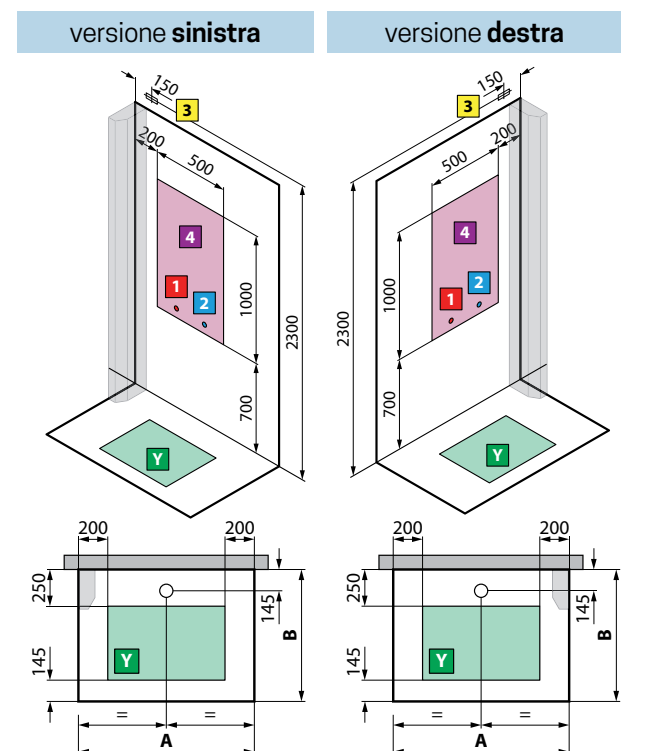
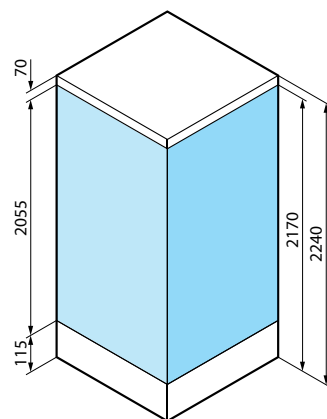

modello	A ± 4	B ± 4
<b>A+F100x80</b>	998	798
<b>2P+2F120x80</b>	1198	798

**CARATTERISTICHE IDRAULICHE:**  
 Pressione dinamica ottimale 2÷5 bar  
 Acqua calda 1/2"  
 Acqua fredda 1/2"  
 Allaccio sifone con raccordo ø 40 mm

**CARATTERISTICHE ELETTRICHE:**  
 Tensione 220 - 230 V  
 Frequenza 50/60 Hz  
 Potenza massima assorbita: 2600 W  
 Potenza nominale: 2500 W

**ATTENZIONE!** Installare a monte dell'apparecchio un interruttore differenziale da 30mA provvisto di interruttore onnipolare con apertura minima dei contatti ≥ 3 mm.