

GLAX 2 2.0 2P



205 cm



6 mm
Porta



5 mm
pareti



**CABINA MULTIFUNZIONE ASIMMETRICA,
APERTURA 1 ANTA SCORREVOLE E 1 FISSA IN LINEA CON 1 FISSO LATERALE**

Design Marco Pellici

Misure				Codice	Installazione		Miscelatore		Vetro	Scelta finitura				
Dimensioni (cm)	Piatto doccia (cm)	Altezza totale (cm)	Entrata (cm)		D	S	M	T	1	UH	UU	HU	BB	TU
		C	*		Destra	Sinistra	Meccanico	Termostatico	Trasparente	Bianco	Total White	Nero	Silver	Corda

HYDRO														
					D	S	M1-	T1-	1	UH	UU	HU	BB	TU
120 X 80	4,5	217	49	G222P120										
120 X 80	11,5	224	49	G222P129										
140 X 80	4,5	217	60	G222P140										
140 X 80	12,5	225	60	G222P149										
120 X 90	4,5	217	49	G222P290										
120 X 90	11,5	224	49	G222P299										
140 X 90	4,5	218	60	G222P490										
140 X 90	12,5	225	60	G222P499										

HYDRO PLUS														
					D	S	M1L-	T1L-	1	UH	UU	HU	BB	TU
120 X 80	4,5	217	49	G222P120										
120 X 80	11,5	224	49	G222P129										
140 X 80	4,5	217	60	G222P140										
140 X 80	12,5	225	60	G222P149										
120 X 90	4,5	217	49	G222P290										
120 X 90	11,5	224	49	G222P299										
140 X 90	4,5	218	60	G222P490										
140 X 90	12,5	225	60	G222P499										

HAMMAM														
					D	S	M5-	T5-	1	UH	UU	HU	BB	TU
120 X 80	4,5	217	49	G222P120										
120 X 80	11,5	224	49	G222P129	●	●		●	●					
140 X 80	4,5	217	60	G222P140										
140 X 80	12,5	225	60	G222P149										
120 X 90	4,5	217	49	G222P290										
120 X 90	11,5	224	49	G222P299										
140 X 90	4,5	218	60	G222P490										
140 X 90	12,5	225	60	G222P499										





GLAX 2 2.0

GLAX 2 2.0 2P CORDA

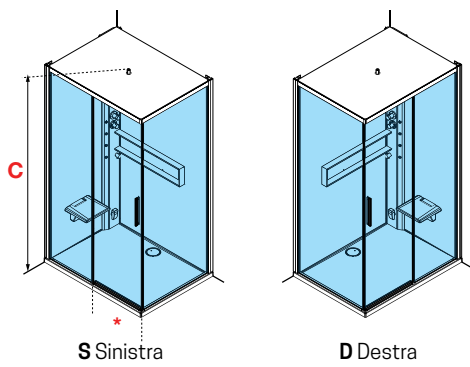



WHITE



TOTAL WHITE



BLACK



SILVER



CORDA

GLAX 2 2.0 | FINITURE

	PROFILI	MANIGLIA	COLONNA + MENSOLA	PARETI FONDO	PIATTO	CUPOLINO *	SEDILE *
WHITE	Nero opaco	Nero opaco	Bianco opaco	Nero	Bianco opaco	Bianco opaco	Bianco
TOTAL WHITE	Bianco opaco	Bianco opaco	Bianco opaco	Bianco	Bianco opaco	Bianco opaco	Bianco
BLACK	Bianco opaco	Bianco opaco	Nero opaco	Bianco	Nero goffrato	Nero opaco	Bianco
SILVER	Silver	Cromo	Silver	Bianco	Bianco lucido	Bianco opaco	Bianco
CORDA	Bianco opaco	Bianco opaco	Corda	Bianco	Corda	Corda	Bianco

* disponibili a seconda dell'allestimento

GLAX 2 2.0 | FUNZIONI E DOTAZIONI (disponibili a seconda dell'allestimento)



Miscelatore meccanico o termostatico e doccia a mano con flessibile orientabile

Tettuccio con soffione doccia

Sistema di idromassaggio verticale

Ripiani d'appoggio

Bluetooth

Sedile reclinabile

Pannello di controllo elettronico soft-touch

Cromolight (versione hammam+hydro plus)
Luce led (versione hydro)

HAMMAM (Sauna di vapore + erogatore di vapore con dispenser di aromi)

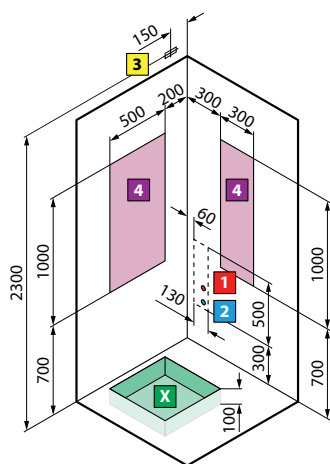
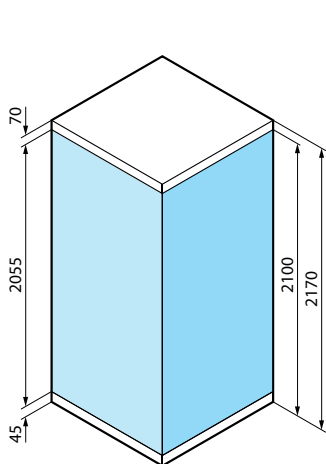

per modelli
A80 - A90 - A100 - GF80 - GF90 - R90 - R100

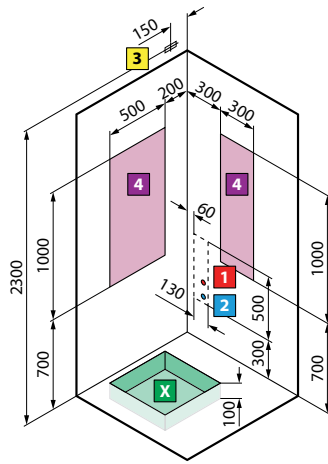

versione **destra**

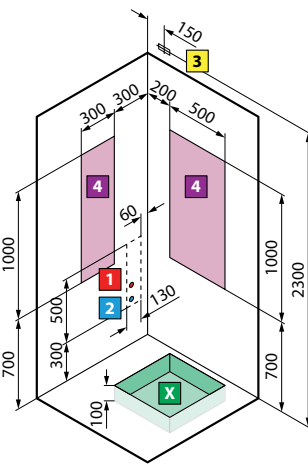

versione **sinistra**
per mod. **A90x70 - A100x70 - A100x80 - 2P 120x80 - 2P 120x90**

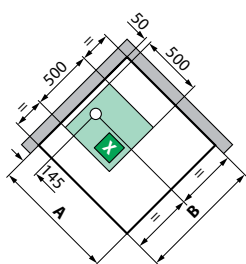

modello	A ± 3	B ± 3
A80	796	796
A90	896	896
A 100	996	996
GF80	796	796
GF90	896	896

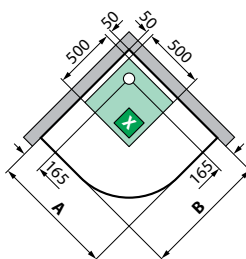

modello	A ± 3	B ± 3
R90	896	896
R100	996	996

S INSTALLAZIONE A SINISTRA

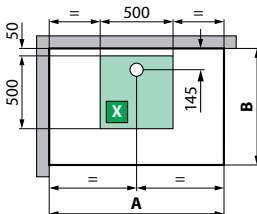

D INSTALLAZIONE A DESTRA

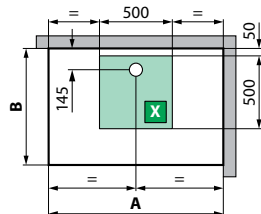

modello	A ± 3	B ± 3
A90x70	896	696
A100x70	996	696
A100x80	996	796
2P120x80	1196	796
2P120x90	1196	896

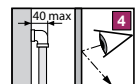
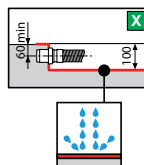
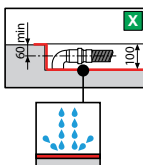

ATTENZIONE!
Può essere dannoso ai portatori di pacemakers

Non ispezionabile

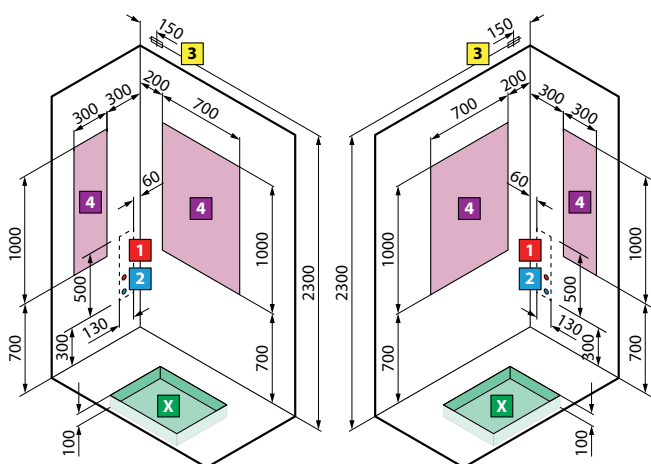

versione **sinistra**

versione **destra**

per mod. **2P140x80 - 2P140x90**

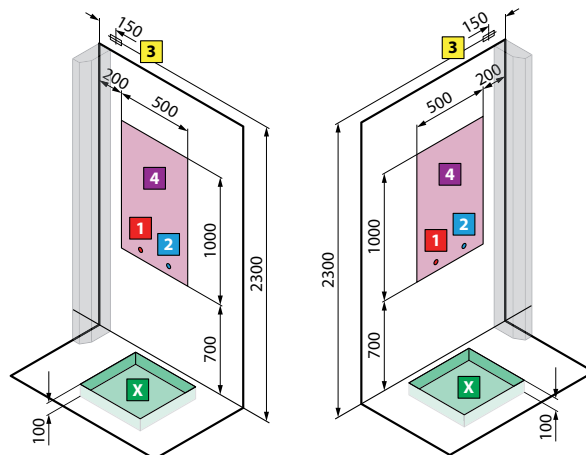

versione **sinistra**

versione **destra**

per mod. **A100x80**

per mod. **A100x80 - 2P120x80**

S INSTALLAZIONE A SINISTRA

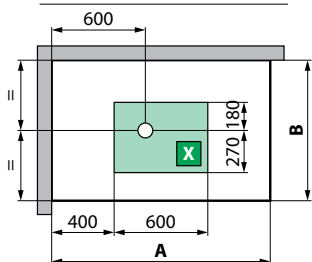

D INSTALLAZIONE A DESTRA

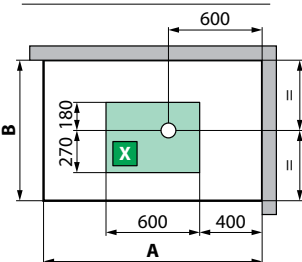

modello	A ± 3	B ± 3
2P140x80	1394	794
2P140x90	1394	894

S INSTALLAZIONE A SINISTRA

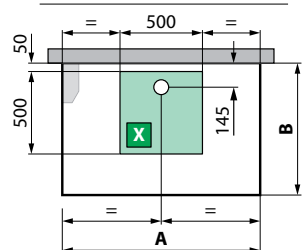

D INSTALLAZIONE A DESTRA

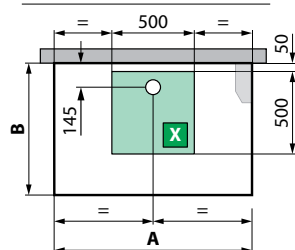

modello	A ± 3	B ± 3
A+F100x80	996	796
2P+2F120x80	1196	796

CARATTERISTICHE IDRAULICHE:

Pressione dinamica ottimale 2÷5 bar
 Acqua calda 1/2"
 Acqua fredda 1/2"
 Allaccio sifone con raccordo \varnothing 40 mm

CARATTERISTICHE ELETTRICHE:

Tensione 220 - 230 V
 Frequenza 50/60 Hz
 Potenza massima assorbita: 2600 W
 Potenza nominale: 2500 W

ATTENZIONE! Installare a monte dell'apparecchio un interruttore differenziale da 30mA provvisto di interruttore onnipolare con apertura minima dei contatti \geq 3 mm.

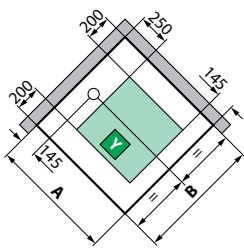
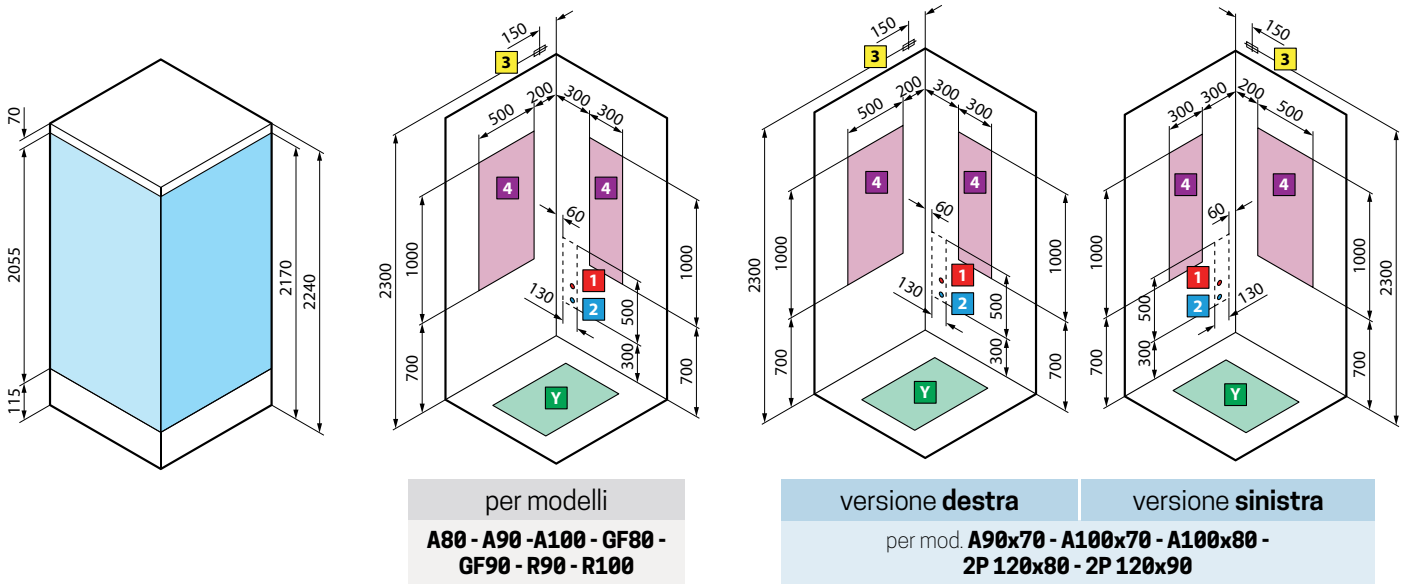

modello	A ± 4	B ± 4
A80	798	798
A90	898	898
A 100	998	998
GF80	798	798
GF90	898	898

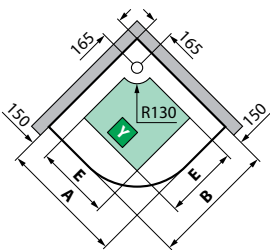

modello	A ± 4	B ± 4	E
R90	898	898	500
R100	998	998	600

S INSTALLAZIONE A SINISTRA

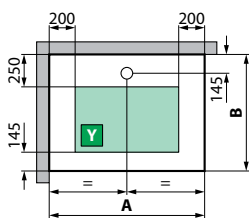

D INSTALLAZIONE A DESTRA

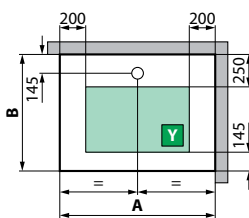

modello	A ± 4	B ± 4
A90x70	898	698
A100x70	998	698
A100x80	998	798
2P120x80	1198	798
2P120x90	1198	898

1

2

3

±10 mm

ATTENZIONE!
Può essere dannoso ai portatori di pacemakers

Non ispezionabile

GLAX 2.0 PIATTO 125

DISEGNI TECNICI

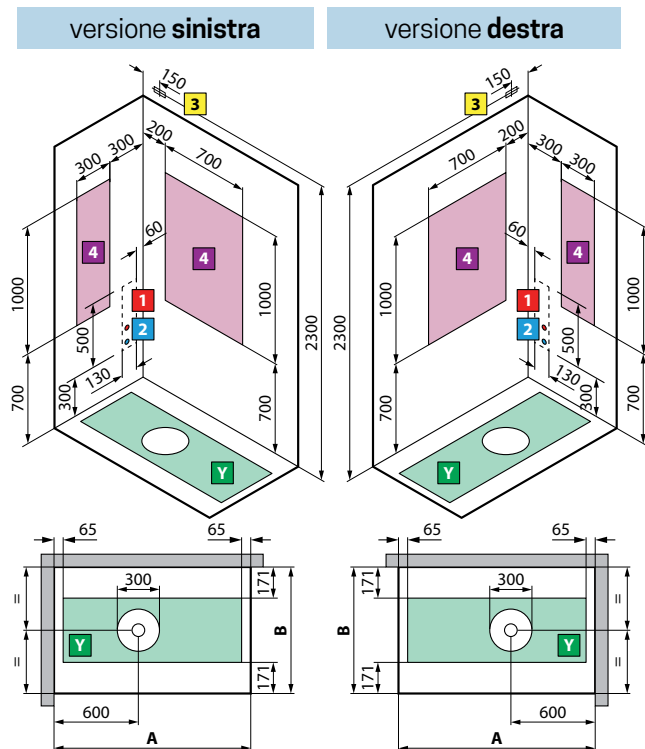
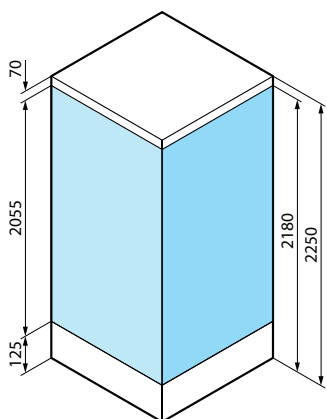

modello	A ± 3	B ± 3
2P140x80	1398	798
2P140x90	1398	898

GLAX 2.0 PIATTO 115

DISEGNI TECNICI

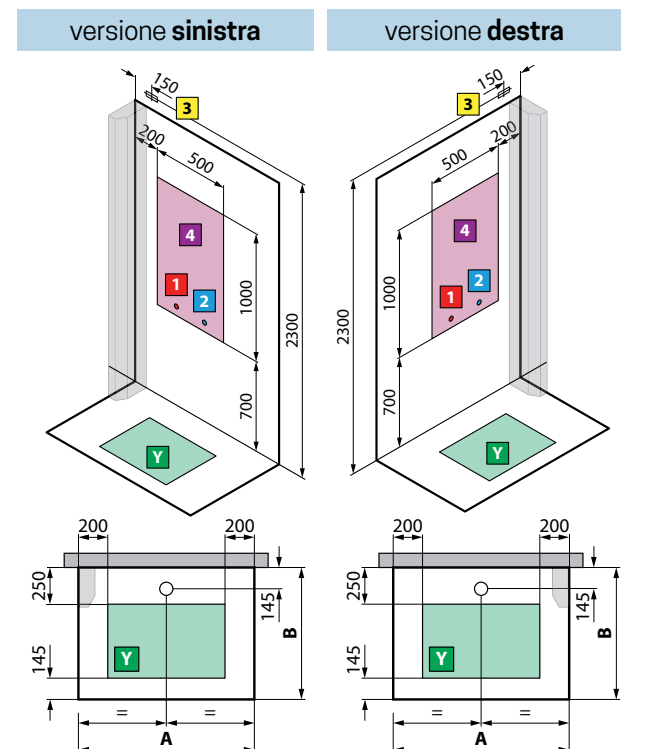
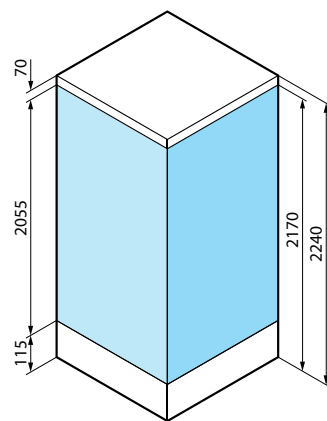

modello	A ± 4	B ± 4
A+F100x80	998	798
2P+2F120x80	1198	798

CARATTERISTICHE IDRAULICHE:
 Pressione dinamica ottimale 2÷5 bar
 Acqua calda 1/2"
 Acqua fredda 1/2"
 Allaccio sifone con raccordo ø 40 mm

CARATTERISTICHE ELETTRICHE:
 Tensione 220 - 230 V
 Frequenza 50/60 Hz
 Potenza massima assorbita: 2600 W
 Potenza nominale: 2500 W

ATTENZIONE! Installare a monte dell'apparecchio un interruttore differenziale da 30mA provvisto di interruttore onnipolare con apertura minima dei contatti ≥ 3 mm.