

GLAX 1 2.0 G+F



205 cm 6 mm Porta 5 mm pareti

CABINA MULTIFUNZIONE, APERTURA 1 ANTA BATTENTE CON FISSO LATERALE

Design Marco Pellici

Misure				Codice	Installazione		Miscelatore		Vetro	Scelta finitura		
Dimensioni (cm)	Piatto doccia (cm)	Altezza totale (cm)	Entrata (cm)		D	S	M	T	1	UU	HH	BB
		C	*		Destra	Sinistra	Meccanico	Termostatico	Trasparente	Bianco	Nero	Silver

STANDARD												
					D	S	M-	T-	1	UU	HH	BB
80 X 80	4,5	210	61	G21GF80								
80 X 80	11,5	217	61	G21GF89								
90 X 90	4,5	210	71	G21GF90								
90 X 90	11,5	217	71	G21GF99								

STANDARD + TETTuccio												
					D	S	MF-	TF-	1	UU	HH	BB
80 X 80	4,5	217	61	G21GF80								
80 X 80	11,5	224	61	G21GF89								
90 X 90	4,5	217	71	G21GF90								
90 X 90	11,5	224	71	G21GF99								

STANDARD+TETTuccio+LIGHT												
					D	S	MFL-	TFL-	1	UU	HH	BB
80 X 80	4,5	217	61	G21GF80								
80 X 80	11,5	224	61	G21GF89								
90 X 90	4,5	217	71	G21GF90								
90 X 90	11,5	224	71	G21GF99								

HAMMAM												
					D	S	M5-	T5-	1	UU	HH	BB
80 X 80	4,5	217	61	G21GF80								
80 X 80	11,5	224	61	G21GF89								
90 X 90	4,5	217	71	G21GF90								
90 X 90	11,5	224	71	G21GF99								



GLAX 1.2.0

GLAX 1.2.0 G BLACK

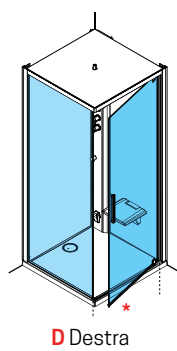
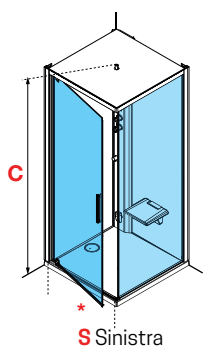



WHITE



BLACK



SILVER









GLAX 1 2.0 | FINITURE

	PROFILI	MANIGLIA	COLONNA	PORTASAPONE	PARETI DI FONDO	PIATTO	TETTUCCIO *	SEDILE *
WHITE	Bianco opaco	Bianco opaco	Bianco opaco	Bianco opaco	Bianco	Bianco lucido	Bianco opaco	Bianco
BLACK	Nero opaco	Nero opaco	Nero opaco	Nero opaco	Bianco	Bianco lucido	Bianco opaco	Bianco
SILVER	Silver	Cromo	Silver	Cromo	Bianco	Bianco lucido	Bianco opaco	Bianco

* disponibili a seconda dell' allestimento

GLAX 1 2.0 | FUNZIONI E DOTAZIONI (disponibili a seconda dell'allestimento)



-   Miscelatore meccanico o termostatico e doccia a mano con flessibile orientabile
-   Tettuccio con soffione doccia
-  Ripiani d'appoggio
-  Bluetooth
-  Sedile reclinabile
-  Pannello di controllo elettronico soft-touch
-   Cromolight (versione sauna basic)
Luce led (versione standard+tettuccio+light)
-  HAMMAM (Sauna di vapore + erogatore di vapore con dispenser di aromi)

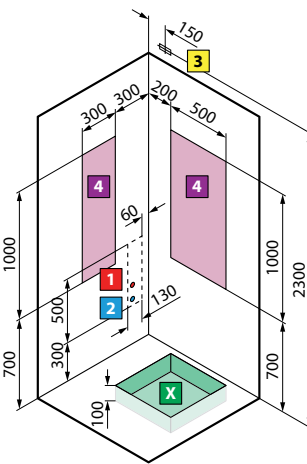
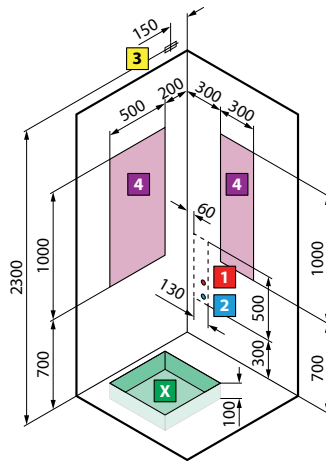
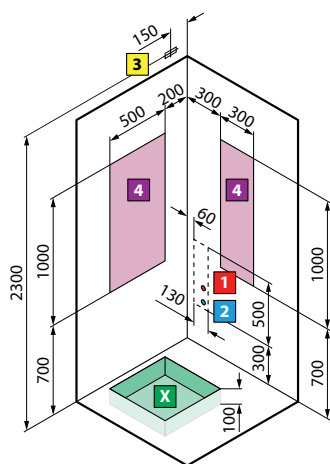
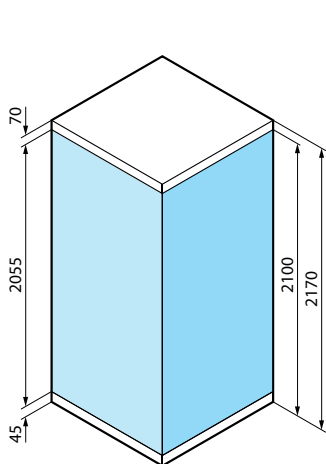

per modelli
A80 - A90 - A100 - GF80 - GF90 - R90 - R100

versione **destra** versione **sinistra**
per mod. **A90x70 - A100x70 - A100x80 - 2P120x80 - 2P120x90**

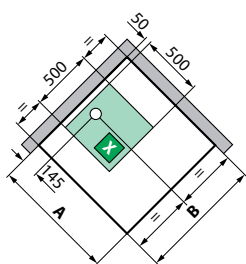

modello	A ± 3	B ± 3
A80	796	796
A90	896	896
A 100	996	996
GF80	796	796
GF90	896	896

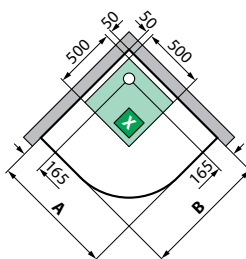

modello	A ± 3	B ± 3
R90	896	896
R100	996	996

S INSTALLAZIONE A SINISTRA

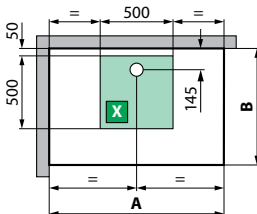

D INSTALLAZIONE A DESTRA

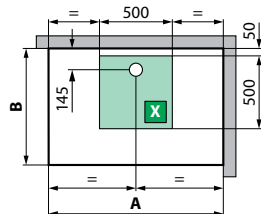

modello	A ± 3	B ± 3
A90x70	896	696
A100x70	996	696
A100x80	996	796
2P120x80	1196	796
2P120x90	1196	896

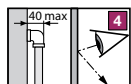
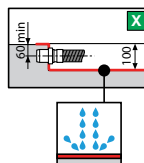
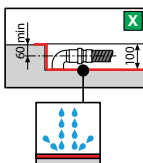

Non ispezionabile

ATTENZIONE!
Può essere dannoso ai portatori di pacemakers

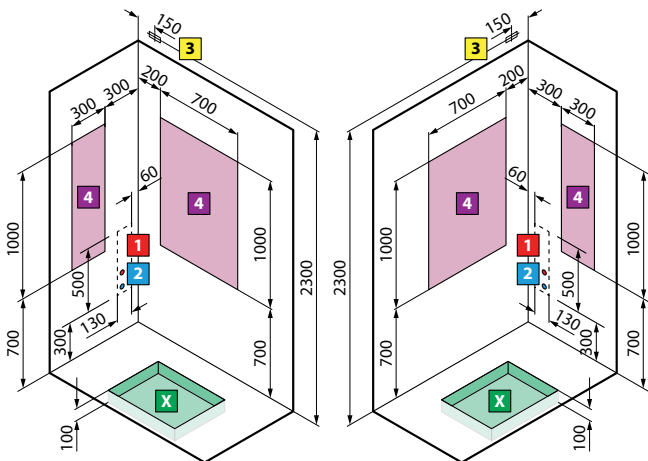

versione **sinistra**

versione **destra**

per mod. **2P140x80 - 2P140x90**

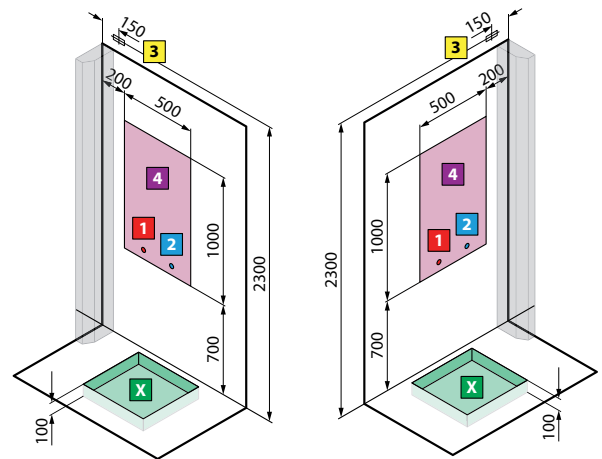

versione **sinistra**

versione **destra**

per mod. **A100x80**

per mod. **A100x80 - 2P120x80**

S INSTALLAZIONE A SINISTRA

D INSTALLAZIONE A DESTRA

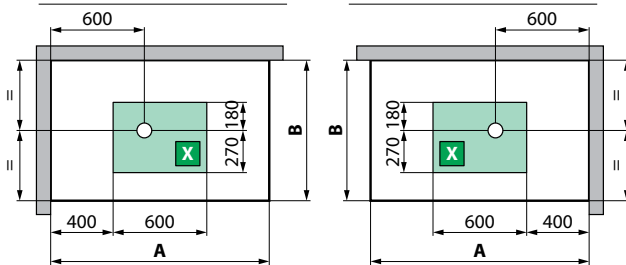

modello	A ± 3	B ± 3
2P140x80	1394	794
2P140x90	1394	894

S INSTALLAZIONE A SINISTRA

D INSTALLAZIONE A DESTRA

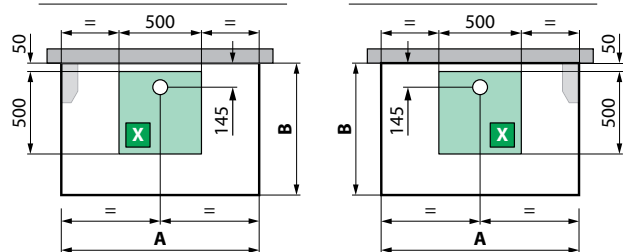

modello	A ± 3	B ± 3
A+F100x80	996	796
2P+2F120x80	1196	796

CARATTERISTICHE IDRAULICHE:

Pressione dinamica ottimale 2÷5 bar
 Acqua calda 1/2"
 Acqua fredda 1/2"
 Allaccio sifone con raccordo \varnothing 40 mm

CARATTERISTICHE ELETTRICHE:

Tensione 220 - 230 V
 Frequenza 50/60 Hz
 Potenza massima assorbita: 2600 W
 Potenza nominale: 2500 W

ATTENZIONE! Installare a monte dell'apparecchio un interruttore differenziale da 30mA provvisto di interruttore onnipolare con apertura minima dei contatti \geq 3 mm.

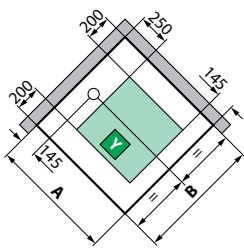
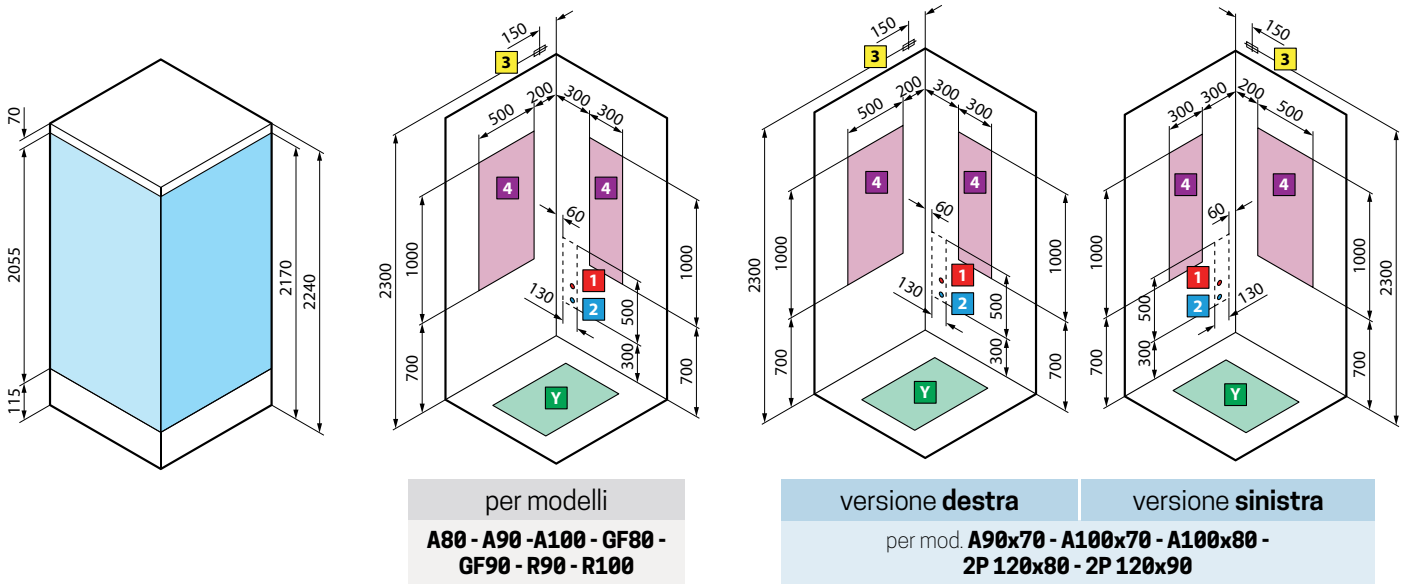

modello	A ± 4	B ± 4
A80	798	798
A90	898	898
A 100	998	998
GF80	798	798
GF90	898	898

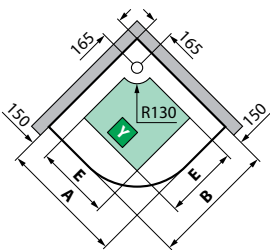

modello	A ± 4	B ± 4	E
R90	898	898	500
R100	998	998	600

S INSTALLAZIONE A SINISTRA

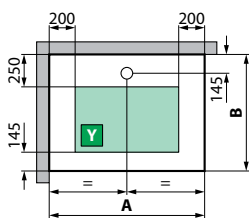

D INSTALLAZIONE A DESTRA

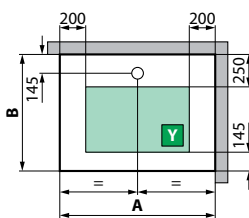

modello	A ± 4	B ± 4
A90x70	898	698
A100x70	998	698
A100x80	998	798
2P120x80	1198	798
2P120x90	1198	898

1

2

3

⚠
±10 mm

Non ispezionabile

ATTENZIONE!
Può essere dannoso ai portatori di pacemakers

GLAX 2.0 PIATTO 125

DISEGNI TECNICI

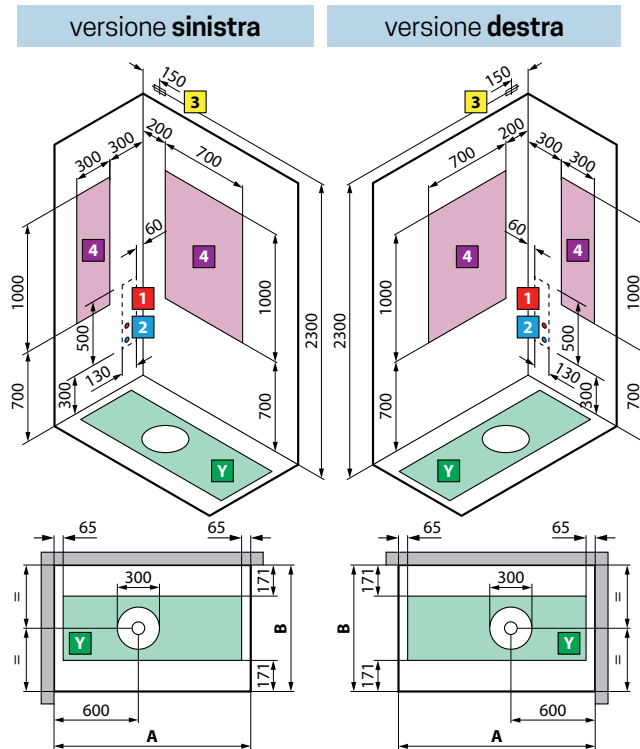
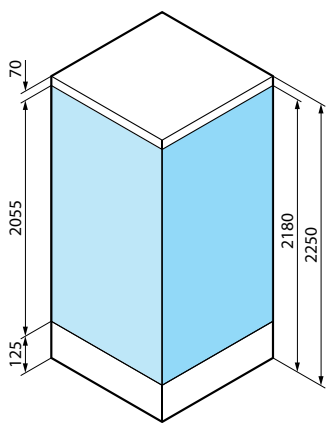

modello	A ± 3	B ± 3
2P140x80	1398	798
2P140x90	1398	898

GLAX 2.0 PIATTO 115

DISEGNI TECNICI

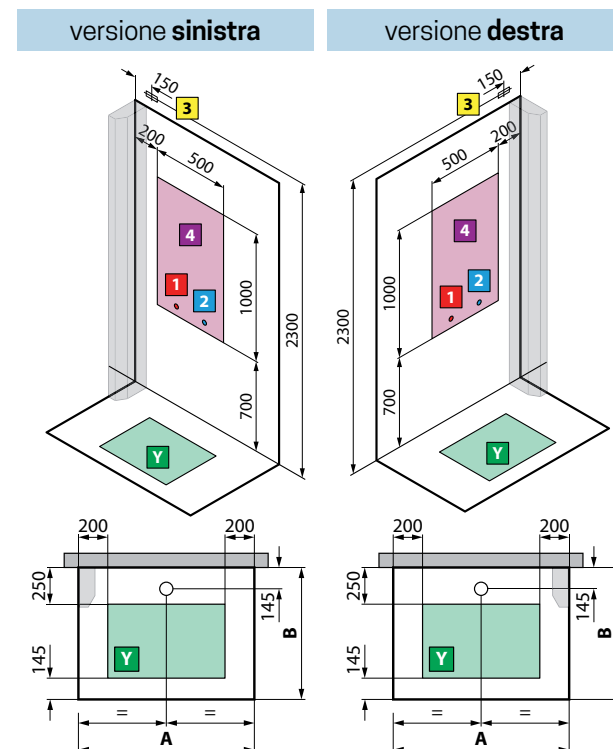
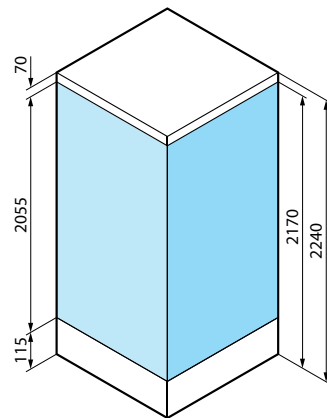

modello	A ± 4	B ± 4
A+F100x80	998	798
2P+2F120x80	1198	798

CARATTERISTICHE IDRAULICHE:
 Pressione dinamica ottimale 2÷5 bar
 Acqua calda 1/2"
 Acqua fredda 1/2"
 Allaccio sifone con raccordo ø 40 mm

CARATTERISTICHE ELETTRICHE:
 Tensione 220 - 230 V
 Frequenza 50/60 Hz
 Potenza massima assorbita: 2600 W
 Potenza nominale: 2500 W

ATTENZIONE! Installare a monte dell'apparecchio un interruttore differenziale da 30mA provvisto di interruttore onnipolare con apertura minima dei contatti ≥ 3 mm.