

CALYPSO

VASCA RETTANGOLARE

| Misure | | | Capacità | Codice | Scelta rubinetteria + finitura vasca | | | Installazione | | Scelta struttura | | | |
|--------|---|-----|----------|--------|---------------------------------------|---|---|---------------|--------|------------------|------------|------------|------------|
| Cm | H | lt. | | | Colonna di scarico senza rubinetteria | Colonna di scarico con erogazione da troppo pieno | Colonna di scarico + rubinetteria bordo vasca | Sinistra | Destra | Con telaio | 1 Pannello | 2 Pannelli | 3 Pannelli |



STANDARD DA INCASSO

| | | | | | | | | | | | | | |
|----------|----|-----|--------------------|--|--|--|--|--|--|--|--|--|--|
| 150 x 70 | 55 | 150 | CAL115070-A | | | | | | | | | | |
| 160 x 70 | 55 | 160 | CAL116070-A | | | | | | | | | | |
| 170 x 70 | 55 | 170 | CAL117070-A | | | | | | | | | | |
| 170 x 75 | 55 | 180 | CAL117075-A | | | | | | | | | | |
| 170 x 80 | 55 | 190 | CAL117080-A | | | | | | | | | | |
| 180 x 80 | 55 | 200 | CAL118080-A | | | | | | | | | | |

STANDARD CON TELAIO

| | | | | C- | E- | F- | | | A0 | A1 | A2 | A3 |
|----------|----|-----|------------------|----|----|----|--|--|----|----|----|----|
| 150 x 70 | 55 | 150 | CAL215070 | | | | | | | | | |
| 160 x 70 | 55 | 160 | CAL216070 | | | | | | | | | |
| 170 x 70 | 55 | 170 | CAL217070 | | | | | | | | | |
| 170 x 75 | 55 | 180 | CAL217075 | | | | | | | | | |
| 170 x 80 | 55 | 190 | CAL217080 | | | | | | | | | |
| 180 x 80 | 55 | 200 | CAL218080 | | | | | | | | | |

HYDRO CON TELAIO SENZA DISINFEZIONE

| | | | | C | E | F | S- | D- | A0K | A1K | A2K | A3K |
|----------|----|-----|-------------------|---|---|---|----|----|-----|-----|-----|-----|
| 150 x 70 | 55 | 150 | CAL5150700 | | | | | | | | | |
| 160 x 70 | 55 | 160 | CAL5160700 | | | | | | | | | |
| 170 x 70 | 55 | 170 | CAL5170700 | | | | | | | | | |
| 170 x 75 | 55 | 180 | CAL5170750 | | | | | | | | | |
| 170 x 80 | 55 | 190 | CAL5170800 | | | | | | | | | |
| 180 x 80 | 55 | 200 | CAL5180800 | | | | | | | | | |

HYDRO CON TELAIO E DISINFEZIONE

| | | | | C | E | F | S- | D- | A0K | A1K | A2K | A3K |
|----------|----|-----|-------------------|---|---|---|----|----|-----|-----|-----|-----|
| 150 x 70 | 55 | 150 | CAL315070P | | | | | | | | | |
| 160 x 70 | 55 | 160 | CAL316070P | | | | | | | | | |
| 170 x 70 | 55 | 170 | CAL317070P | | | | | | | | | |
| 170 x 75 | 55 | 180 | CAL317075P | | | | | | | | | |
| 170 x 80 | 55 | 190 | CAL317080P | | | | | | | | | |
| 180 x 80 | 55 | 200 | CAL318080P | | | | | | | | | |

HYDRO PLUS CON TELAIO

| | | | | C | E | F | S- | D- | A0K | A1K | A2K | A3K |
|----------|----|-----|-------------------|---|---|---|----|----|-----|-----|-----|-----|
| 150 x 70 | 55 | 150 | CAL415070P | | | | | | | | | |
| 160 x 70 | 55 | 160 | CAL416070P | | | | | | | | | |
| 170 x 70 | 55 | 170 | CAL417070P | | | | | | | | | |
| 170 x 75 | 55 | 180 | CAL417075P | | | | | | | | | |
| 170 x 80 | 55 | 190 | CAL417080P | | | | | | | | | |
| 180 x 80 | 55 | 200 | CAL418080P | | | | | | | | | |

ECO CON TELAIO SENZA DISINFEZIONE

| | | | | C | E | F | S- | D- | A0K | A1K | A2K | A3K |
|----------|----|-----|----------------------|---|---|---|----|----|-----|-----|-----|-----|
| 150 x 70 | 55 | 150 | CAL615070MCS- | | | | | | | | | |
| 160 x 70 | 55 | 160 | CAL616070MCS- | | | | | | | | | |
| 170 x 70 | 55 | 170 | CAL617070MCS- | | | | | | | | | |
| 170 x 75 | 55 | 180 | CAL617075MCS- | | | | | | | | | |
| 170 x 80 | 55 | 190 | CAL617080MCS- | | | | | | | | | |
| 180 x 80 | 55 | 200 | CAL618080MCS- | | | | | | | | | |

PER TUTTI GLI OPTIONAL VEDI PAG. 549, 550



FINITURA
VASCA



Bianco
lucido

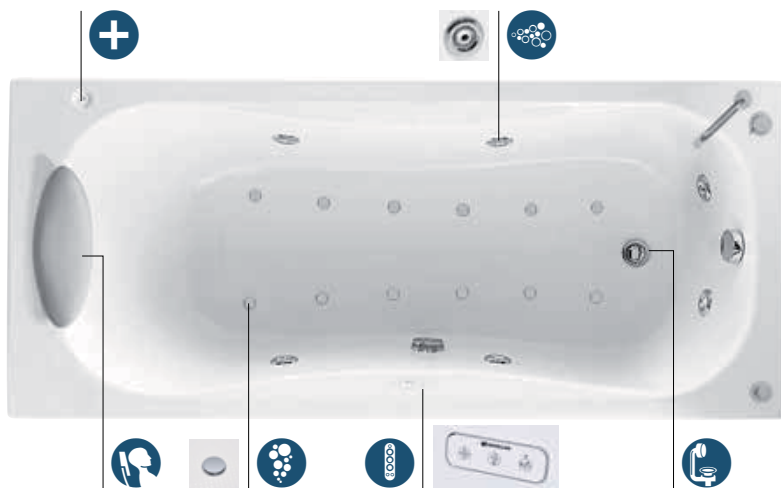

SINISTRA

DESTRA

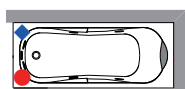
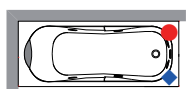

VERSIONE STANDARD

- RUBINETTERIA
- ◆ DOCCETTA

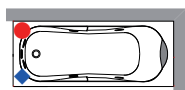
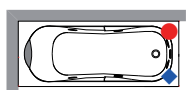

VERSIONE HYDRO

- RUBINETTERIA
- ◆ DOCCETTA



FUNZIONI E DOTAZIONI

(disponibili a seconda dell'allestimento)



Massaggio Airpool (12 jets) a getto d'aria con accensione manuale on/off. Per una **efficace stimolazione cellulare**



Massaggio corpo Whirlpool (6 jets) aria/acqua con regolazione di tempo e intensità manuale o automatica. Per soddisfare qualsiasi esigenza di benessere.



Poggiatesta in materiale antibatterico



Pannello di controllo con funzioni Hydro sequence



Piletta di scarico



Disinfezione

CALYPSO

CALYPSO

OPTIONAL PER VASCHE

POGGIATESTA IN EVA*
per Divina e Divina O



| Codice | Prezzo |
|---------------|--------|
| POGDIV | |

POGGIATESTA IN EVA *
per Divina C



| Codice | Prezzo |
|----------------|--------|
| POGDIVC | |

POGGIATESTA IN EVA*
per Iris versione in nicchia



| Codice | Prezzo |
|----------------|--------|
| POGIRIN | |

POGGIATESTA IN EVA*
per Calos 2.0



| Codice | Prezzo |
|---------------|--------|
| POGCA1 | |

POGGIATESTA IN EVA *
per Calypso



| Codice | Prezzo |
|---------------|--------|
| POGCAL | |

POGGIATESTA IN EVA*
per Vogue



| Codice | Prezzo |
|---------------|--------|
| POGVOG | |

**MENSOLINA PORTAOGGETTI
BORDO VASCA**
per Divina, Divina C, O e F



| Codice | Prezzo |
|-----------------|--------|
| R90PODIV | |

PIANO PORTAOGGETTI SOPRA VASCA
per Divina e Divina F



| Larghezza | Codice | Prezzo |
|-----------|-------------------|--------|
| 70 cm | R90VADIV70 | |
| 75 cm | R90VADIV75 | |
| 80 cm | R90VADIV80 | |
| 90 cm | R90VADIV90 | |

**PROFILO DI FINITURA RIGIDO
IN ALLUMINIO**



| Misure | Codice | Prezzo |
|---------------------|----------------------|--------|
| 1 lato 185 cm | PRV185-30 | |
| 2 lati 185x85 cm | PRV18585-30 | |
| 3 lati 85x185x85 cm | PRV8518585-30 | |

*EVA è un materiale atossico, antibatterico e idrorepellente

OPTIONAL PER VASCHE

PROFILO DI FINITURA I. 400 cm



| Codice | Prezzo |
|--------|--------|
|--------|--------|

PRVA2-A

PROFILO DI FINITURA IN PLASTICA



| Codice | Prezzo |
|--------|--------|
|--------|--------|

PRVA195-30

TUBO DI SCARICO SALVAGOCCIA



| Codice | Prezzo |
|--------|--------|
|--------|--------|

R90SCDOCBV

IRIS, CALOS 2.0, UNA, VOGUE, VENUS, CALYPSO

COLONNA DI SCARICO per vasche senza erogatore



| Codice | Prezzo |
|--------|--------|
|--------|--------|

COLSCAVK-K

COLONNA DI SCARICO CON EROGATORE per vasche con erogatore



| Codice | Prezzo |
|--------|--------|
|--------|--------|

COLSCAE-K

PANNELLO D'ISPEZIONE PER VASCA AD INCASSO 60x33x2 cm



SENSE

| Codice | Prezzo |
|--------|--------|
|--------|--------|

PANISPEL-A

IRIS, CALOS 2.0, UNA, VOGUE, VENUS, CALYPSO, BABY

| Codice | Prezzo |
|--------|--------|
|--------|--------|

PANISP-A

KIT PIEDINI REGOLABILI PER VASCHE AD INCASSO per Sense, Iris, Calos 2.0



| Codice | Prezzo |
|--------|--------|
|--------|--------|

PIEDVASCA

KIT PIEDINI REGOLABILI per Divina, Calos 2.0, Una, Vogue, Venus, Calypso



| Codice | Prezzo |
|--------|--------|
|--------|--------|

PIEDVASCA70

PIEDVASCA75

PIEDVASCA80

PIEDVASCA90

PIEDVASCA100

KIT SOPRAVASCA DIVINA



Per il sopravasca Divina ordinare:

**1 sopravasca Young 2.0 1V/1BSV +
1 kit raccordo vasca**

vedi pag. 580, 582

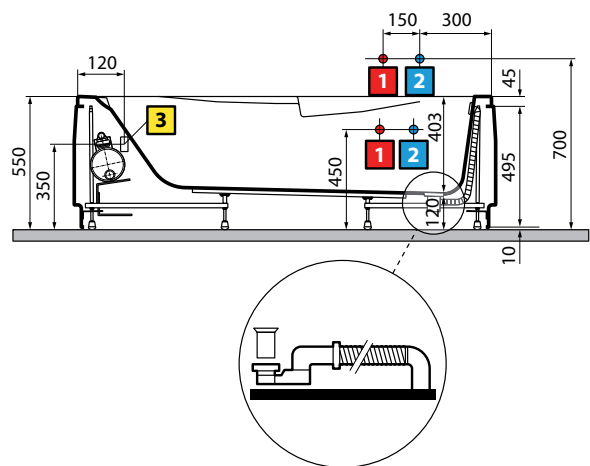
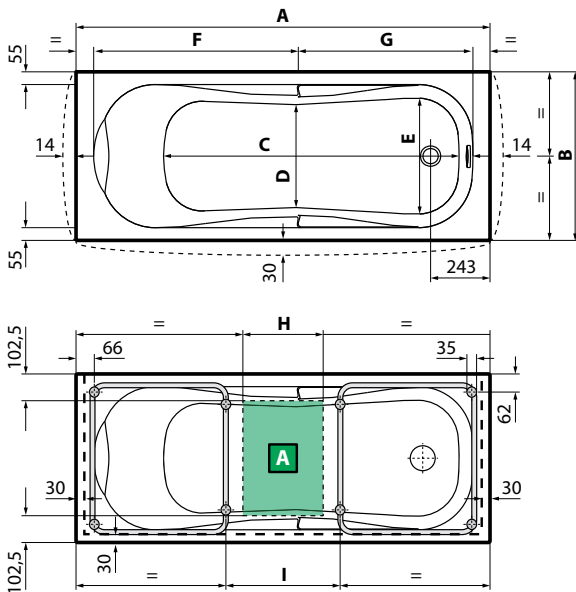

| modello | A | B | C | D | E | F | G | H | I | Capacità litri |
|---------------|------|-----|------|-----|-----|-----|-----|-----|-------|----------------|
| 150x70 | 1495 | 695 | 1000 | 420 | 470 | 730 | 625 | 290 | 412,5 | 150 |
| 160x70 | 1595 | 695 | 1100 | 420 | 470 | 780 | 675 | 390 | 512 | 160 |
| 170x70 | 1695 | 695 | 1200 | 420 | 470 | 830 | 725 | 490 | 611,5 | 170 |
| 170x75 | 1695 | 745 | 1200 | 470 | 520 | 830 | 725 | 370 | 491,5 | 180 |
| 170x80 | 1695 | 795 | 1200 | 500 | 570 | 830 | 725 | 400 | 535 | 190 |
| 180x80 | 1795 | 795 | 1300 | 500 | 570 | 880 | 775 | 500 | 631,5 | 200 |

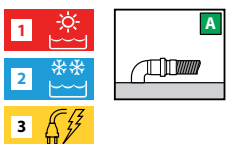

ATTENZIONE!
Può essere dannoso ai portatori di pacemakers

Installare a monte dell'apparecchio un interruttore differenziale da 30mA provvisto di interruttore onnipolare con apertura minima dei contatti ≥ 3 mm.

CARATTERISTICHE IDRAULICHE

5/7 bocchette whirlpool
12 bocchette airpool
Allaccio sifone con raccordo 1 1/2"

CARATTERISTICHE ELETTRICHE

Tensione 220-230 V
Frequenza 50 Hz
Potenza massima assorbita: 950 W
Whirlpool: 550 W
Airpool: 400 W