

# GLAX 2 2.0 R

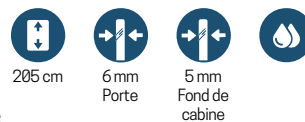

**CABINE DE DOUCHE MULTIFONCTION- 1/4 DE CERCLE, OUVERTURE 2 PORTES COULISSANTES + 2 FIXES**

Design Marco Pellici

Dimensions				Code	Mitigeur		Verre Vitrage	Profilé				
Dimensions (cm)	Receveur de douche (cm)	Hauteur hors-tout (cm)	Passage (cm)		M	T	1	UH	UU	HU	BB	TU
		<b>C</b>	*		Mécanique	Thermostatique	Transparent	Blanc	Total White	Noir mat	Silver	Corda
<b>HYDRO</b>												
					<b>M1-</b>	<b>T1-</b>	<b>1</b>	<b>UH</b>	<b>UU</b>	<b>HU</b>	<b>BB</b>	<b>TU</b>
90 X 90	4,5	217	49	<b>G22R90</b>								
90 X 90	11,5	224	49	<b>G22R99</b>								
100 X 100	4,5	217	49	<b>G22R100</b>								
100 X 100	11,5	224	49	<b>G22R109</b>								
<b>HYDRO PLUS</b>												
					<b>M1L-</b>	<b>T1L-</b>	<b>1</b>	<b>UH</b>	<b>UU</b>	<b>HU</b>	<b>BB</b>	<b>TU</b>
90 X 90	4,5	217	49	<b>G22R90</b>								
90 X 90	11,5	224	49	<b>G22R99</b>								
100 X 100	4,5	217	49	<b>G22R100</b>								
100 X 100	11,5	224	49	<b>G22R109</b>								
<b>HAMMAM</b>												
					<b>M5-</b>	<b>T5-</b>	<b>1</b>	<b>UH</b>	<b>UU</b>	<b>HU</b>	<b>BB</b>	<b>TU</b>
90 X 90	4,5	217	49	<b>G22R90</b>								
90 X 90	11,5	224	49	<b>G22R99</b>								
100 X 100	4,5	217	49	<b>G22R100</b>								
100 X 100	11,5	224	49	<b>G22R109</b>								



GLAX 2 2.0

GLAX 2 2.0 R SILVER

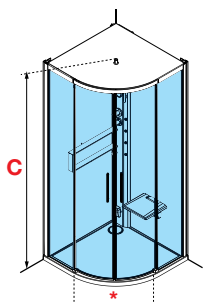



WHITE



TOTAL WHITE



BLACK



SILVER



CORDA

## GLAX 2 2.0 | FINITIONS

	PROFILÉ	POIGNÉE	COLONNE + ETAGÈRE	PANNEAUX DE FOND	RECEVEURS	COIFFE *	SIÈGE *
<b>WHITE</b>	Noir mat	Noir mat	Blanc mat	Verre Noir	Blanc mat	Blanc mat	Blanc
<b>TOTAL WHITE</b>	Blanc mat	Blanc mat	Blanc mat	Verre Blanc	Blanc mat	Blanc mat	Blanc
<b>BLACK</b>	Blanc mat	Blanc mat	Noir mat	Verre Blanc	Noir texturé	Noir mat	Blanc
<b>SILVER</b>	Silver	Chrome	Silver	Verre Blanc	Blanc brillant	Blanc mat	Blanc
<b>CORDA</b>	Blanc mat	Blanc mat	Corda	Verre Blanc	Corda texturé	Corda	Blanc

\* disponible selon la version choisie

## GLAX 2 2.0 | FONCTIONS ET EQUIPEMENTS (disponibles en fonction de la version)

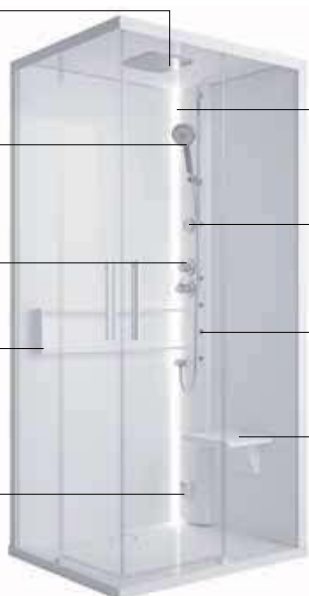

Mitigeur mécanique ou thermostatique et douchette à main avec flexible

Coiffe avec douche zénithale

Hydromassage vertical

Etagère porte-objets

Bluetooth

Siège rabattable

Ecran tactile

Chromolight (versions Hydro Plus et Hammam)  
Lumière LED (version Hydro)

Hammam + Générateur de vapeur avec diffuseur  
d'arômes + filtre adoucisseur pour hammam

# GLAX 2.0 RECEVEUR 45 MM

# DONNÉES TECHNIQUES

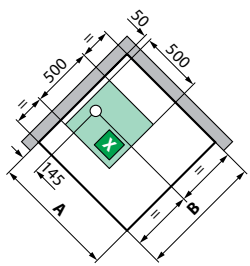
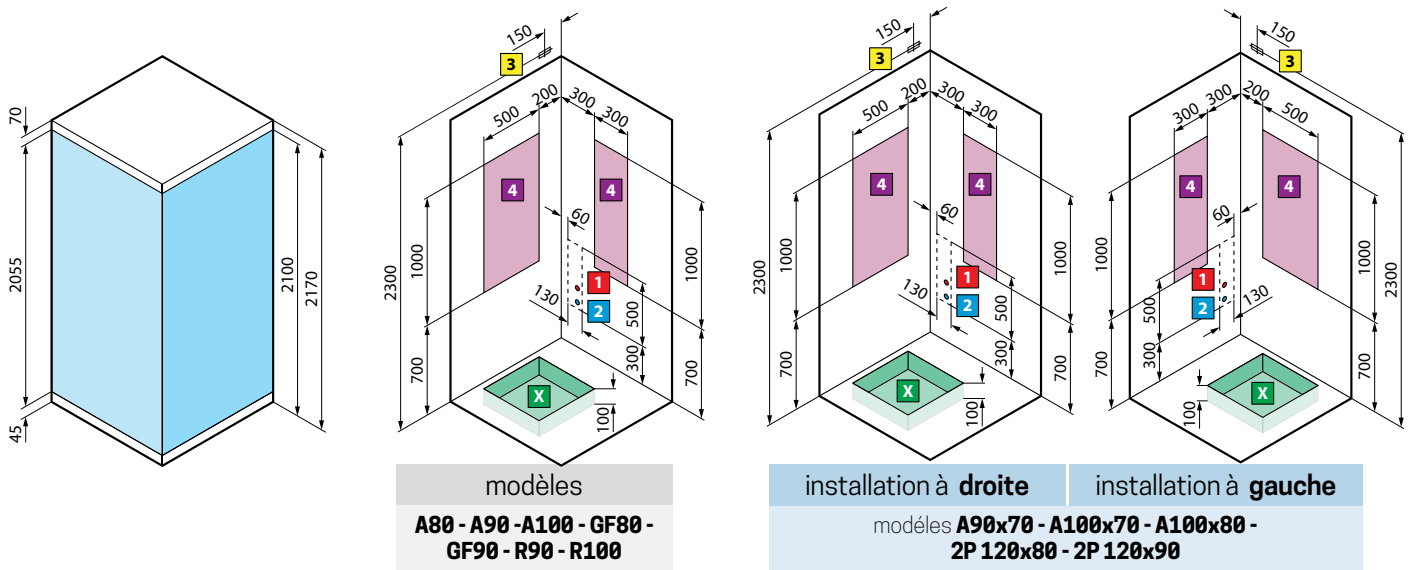

modèle	A ± 3	B ± 3
<b>A80</b>	796	796
<b>A90</b>	896	896
<b>A 100</b>	996	996
<b>GF80</b>	796	796
<b>GF90</b>	896	896

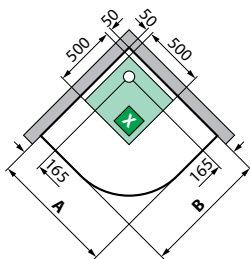

modèle	A ± 3	B ± 3
<b>R90</b>	896	896
<b>R100</b>	996	996

## S INSTALLATION À GAUCHE

## D INSTALLATION À DROITE

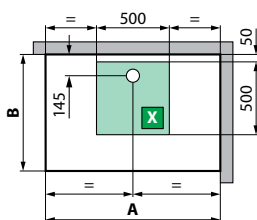
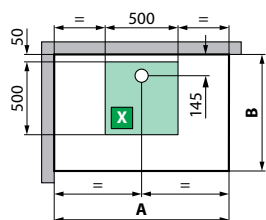

modèle	A ± 3	B ± 3
<b>A90x70</b>	896	696
<b>A100x70</b>	996	696
<b>A100x80</b>	996	796
<b>2P120x80</b>	1196	796
<b>2P120x90</b>	1196	896

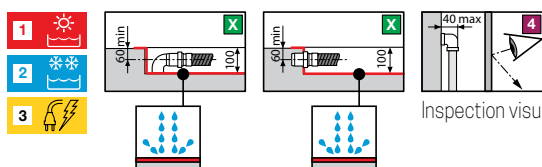

**ATTENTION!**  
Peut être dangereux pour les porteurs de pacemaker

Inspection visuelle pas possible

# GLAX 2.0 RECEVEUR 45 MM

# DONNÉES TECHNIQUES

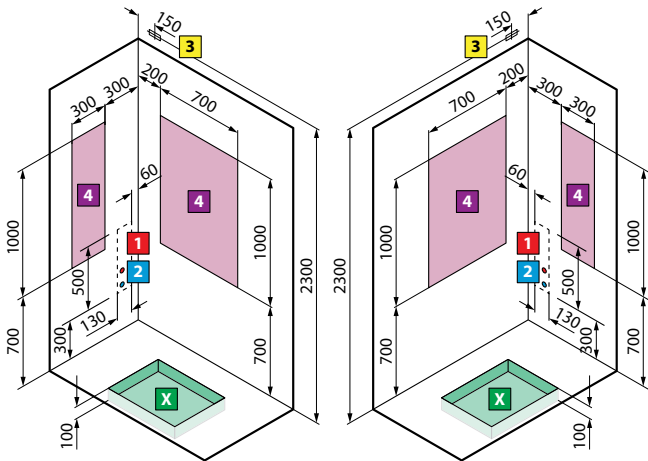

installation à gauche

installation à droite

modèles **2P140x80 - 2P140x90**

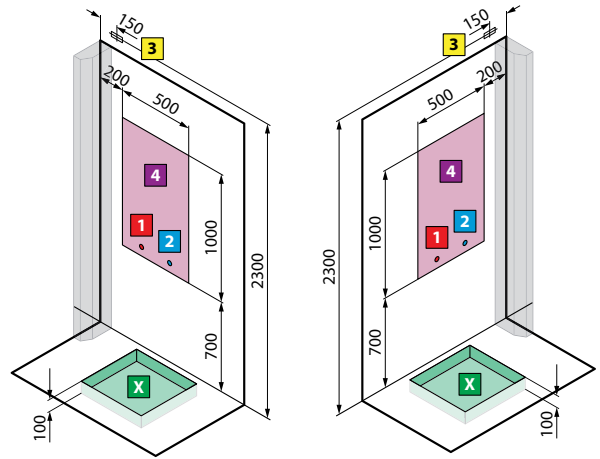

installation à gauche

installation à droite

**A100x80**

modèles  
**A100x80 - 2P120x80**

## S INSTALLATION À GAUCHE

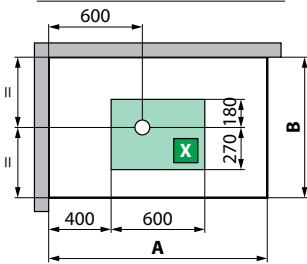

## D INSTALLATION À DROITE

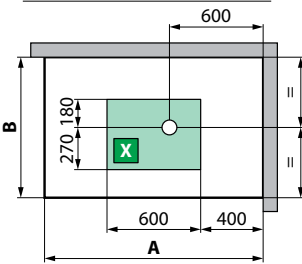

modèle	A ± 3	B ± 3
<b>2P140x80</b>	1394	794
<b>2P140x90</b>	1394	894

## S INSTALLATION À GAUCHE

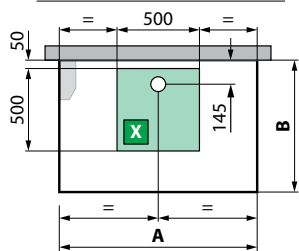

## D INSTALLATION À DROITE

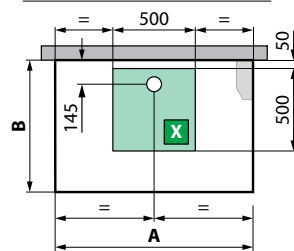

modèle	A ± 3	B ± 3
<b>A+F100x80</b>	996	796
<b>2P+2F120x80</b>	1196	796

### CARACTERISTIQUES HYDRAULIQUES :

Pression dynamique optimale 2÷5 bar  
Eau chaude 1/2"  
Eau froide 1/2"  
Raccordement évacuation ø 40 mm

### CARACTERISTIQUES ELECTRIQUES :

220 - 230 V  
50/60 Hz  
Absorption maximale: 2600 W  
Puissance nominale: 2500 W

**ATTENTION!** En amont de l'appareil, installer un disjoncteur différentiel de 30 mA et un coupe-circuit magnétothermique à déconnexion omnipolaire distance d'ouverture ≥ 3 mm.

# GLAX 2.0 RECEVEUR 115 MM

# DONNÉES TECHNIQUES

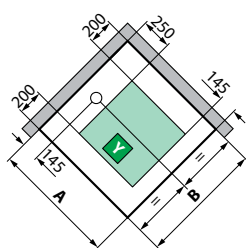
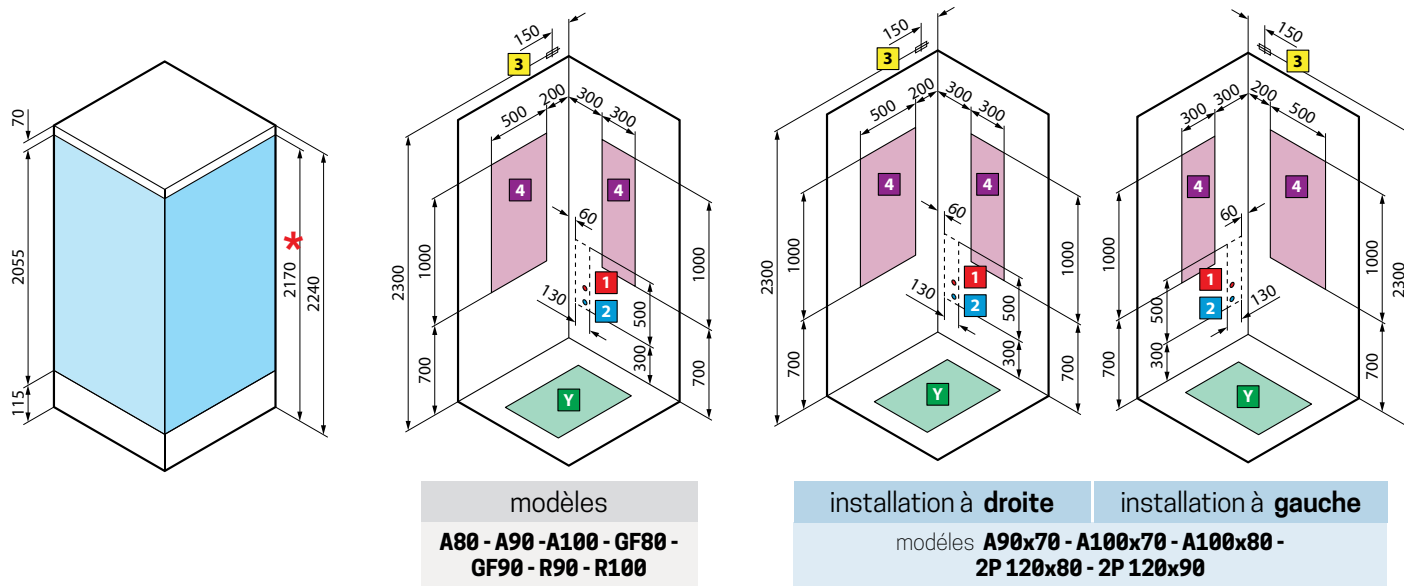

modèle	A ± 4	B ± 4
<b>A80</b>	798	798
<b>A90</b>	898	898
<b>A 100</b>	998	998
<b>GF80</b>	798	798
<b>GF90</b>	898	898

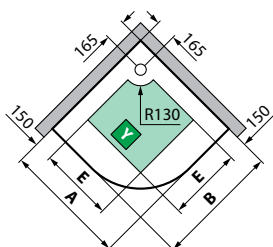

modèle	A ± 4	B ± 4	E
<b>R90</b>	898	898	500
<b>R100</b>	998	998	600

## S INSTALLATION À GAUCHE

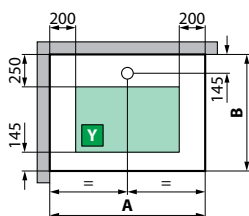

## D INSTALLATION À DROITE

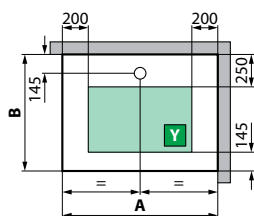

modèle	A ± 4	B ± 4
<b>A90x70</b>	898	698
<b>A100x70</b>	998	698
<b>A100x80</b>	998	798
<b>2P120x80</b>	1198	798
<b>2P120x90</b>	1198	898

1

2

3

±10 mm

Inspection visuelle pas possible

**ATTENTION!**  
Peut être dangereux pour les porteurs de pacemaker

# GLAX 2.0 RECEVEUR 125

# DONNÉES TECHNIQUES

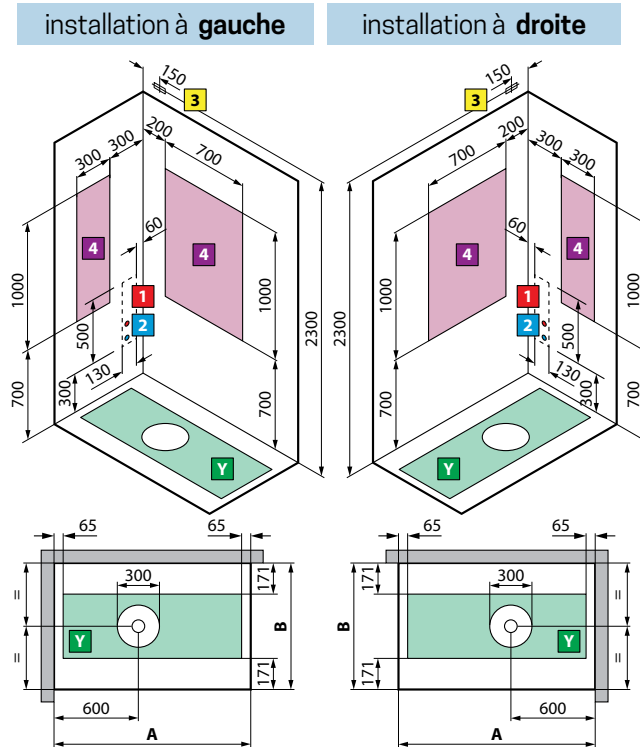
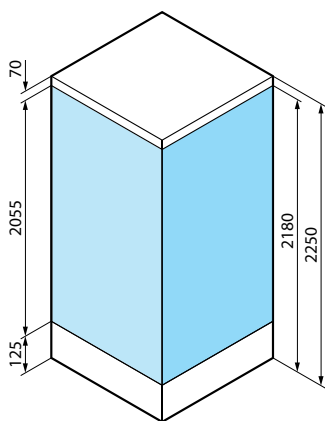

modèle	A ± 3	B ± 3
<b>2P140x80</b>	1398	798
<b>2P140x90</b>	1398	898

# GLAX 2.0 RECEVEUR 115

# DONNÉES TECHNIQUES

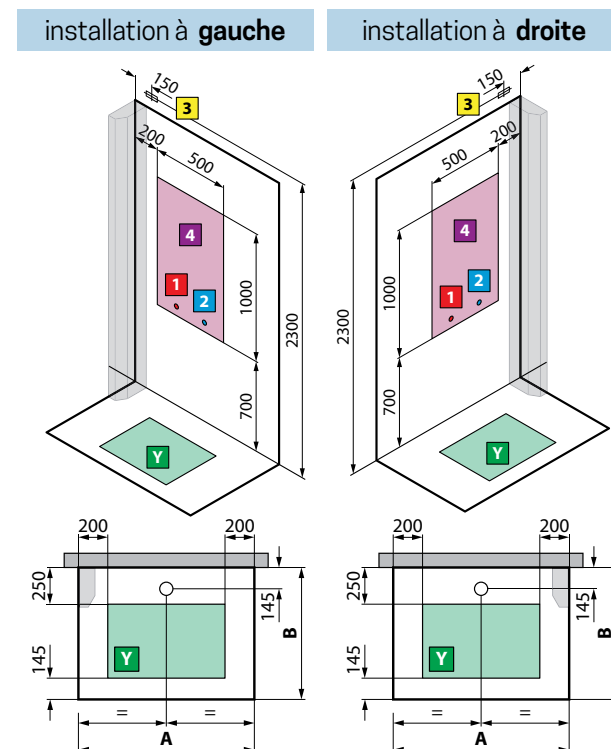
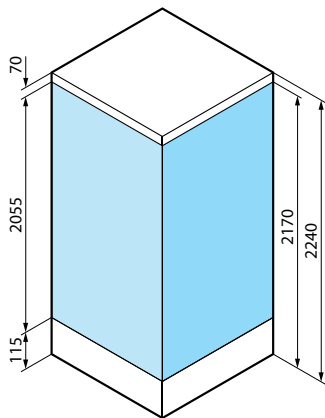

modèle	A ± 4	B ± 4
<b>A+F100x80</b>	998	798
<b>2P+2F120x80</b>	1198	798

### CARACTERISTIQUES HYDRAULIQUES :

Pression dynamique optimale 2÷5 bar  
 Eau chaude 1/2"  
 Eau froide 1/2"  
 Raccordement évacuation ø 40 mm

### CARACTERISTIQUES ELECTRIQUES :

220 - 230 V  
 50/60 Hz  
 Absorption maximale: 2600 W  
 Puissance nominale: 2500 W

**ATTENTION!** En amont de l'appareil, installer un disjoncteur différentiel de 30 mA et un coupe-circuit magnétothermique à déconnexion omnipolaire distance d'ouverture ≥ 3 mm.