



WHITE



TOTAL WHITE



BLACK



SILVER



CORDA

GLAX 2 2.0 | AUSSTATTUNG

	PROFILE	GRIFFE	PANEEL + ABLAGE	RÜCKWÄNDE	DUSCHWANNEN	DACH *	KLAPPSITZ *
WHITE	Schwarz Matt	Schwarz Matt	Weiß Matt	Schwarz	Weiß Matt	Weiß Matt	Weiß
TOTAL WHITE	Weiß Matt	Weiß Matt	Weiß Matt	Weiß	Weiß Matt	Weiß Matt	Weiß
BLACK	Weiß Matt	Weiß Matt	Schwarz Matt	Weiß	Schwarz Matt	Schwarz Matt	Weiß
SILVER	Silber	Chrom	Silber	Weiß	Weiß Glanz	Weiß Matt	Weiß
CORDA	Weiß Matt	Weiß Matt	Corda	Weiß	Corda	Corda	Weiß

* je nach Ausstattungsvariante

GLAX 2 2.0 | FUNKTIONEN UND AUSRÜSTUNG (je nach Version verfügbar)



-   Thermostatmischer oder Mechanischer Armatur
-   Kopfbrause
-  Vertikale Wassermassagedüsen
-  Ablage
-  Bluetooth
-  Klappbarer Sitz
-  Elektronisches Bedienelement Soft-Touch
-   Farblicht (Version Dampfdusche+Hydro Plus) LED Beleuchtung (Version Hydro)
-  Dampfbad+ Aromadisenser für Duftessenzen

GLAX 22.0 A



MULTIFUNKTIONSKABINE A ECKEINSTIEG MIT SCHIEBETÜREN

Design Marco Pellici

Maße				Code	Ausführung		Armatur		Glas	Farbe				
Maße (cm)	Brause-tasse (cm)	Höhe Kabine (cm)	Einstiegs-breite		D	S	M	T	1	UH	UU	HU	BB	TU
		C	*		Rechts	Links	Mechanisch	Thermostat	ESG-Klar	White	Total white	Black	Silver	Corda

HYDRO														
					D	S	M1-	T1-	1	UH	UU	HU	BB	TU
80X80	4,5	217	40	G22A80										
80X80	11,5	224	40	G22A89										
90X90	4,5	217	47	G22A90										
90X90	11,5	224	47	G22A99										
100X100	4,5	217	54	G22A100										
100X100	11,5	224	54	G22A109										
90X70	4,5	217	40	G22A9070										
90X70	11,5	224	40	G22A9079										
100X70	4,5	217	43,5	G22A107										
100X70	11,5	224	43,5	G22A197										
100X80	4,5	217	47,5	G22A108										
100X80	11,5	224	47,5	G22A198										

HYDRO PLUS														
					D	S	M1L-	T1L-	1	UH	UU	HU	BB	TU
80X80	4,5	217	40	G22A80										
80X80	11,5	224	40	G22A89										
90X90	4,5	217	47	G22A90										
90X90	11,5	224	47	G22A99										
100X100	4,5	217	54	G22A100										
100X100	11,5	224	54	G22A109										
90X70	4,5	217	40	G22A9070										
90X70	11,5	224	40	G22A9079										
100X70	4,5	217	43,5	G22A107										
100X70	11,5	224	43,5	G22A197										
100X80	4,5	217	47,5	G22A108										
100X80	11,5	224	47,5	G22A198										

DAMPFBAD														
					D	S	M5-	T5-	1	UH	UU	HU	BB	TU
80X80	4,5	217	40	G22A80										
80X80	11,5	224	40	G22A89										
90X90	4,5	217	47	G22A90										
90X90	11,5	224	47	G22A99										
100X100	4,5	217	54	G22A100										
100X100	11,5	224	54	G22A109										
90X70	4,5	217	40	G22A9070										
90X70	11,5	224	40	G22A9079										
100X70	4,5	217	43,5	G22A107										
100X70	11,5	224	43,5	G22A197										
100X80	4,5	217	47,5	G22A108										
100X80	11,5	224	47,5	G22A198	•	•		•	•					





GLAX 2.2.0 A TOTAL WHITE

80x80 | 90x90 | 100x100

90x70 | 100x70 | 100x80

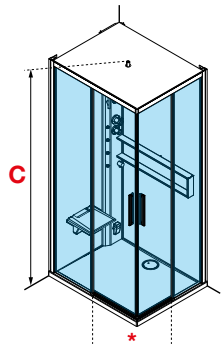
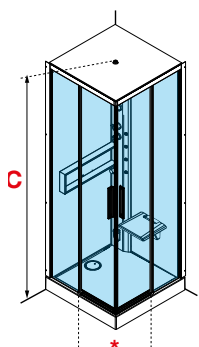

S Links

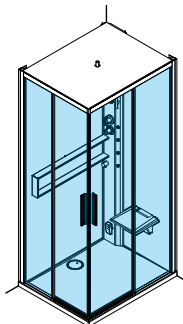

D Rechts

SONDERAUSSTATTUNG

Flexibler Abflussschlauch



Code	Preis
RISCCAB	

Wasserenhärter für Dampfgenerator S.350



Code	Preis
R90FLTATC01	

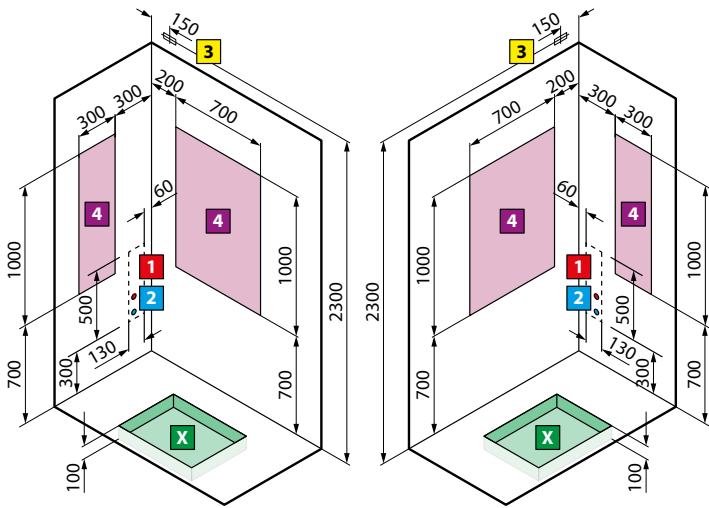

Version **Links**

Version **Rechts**

für mod. **2P140x80 - 2P140x90**

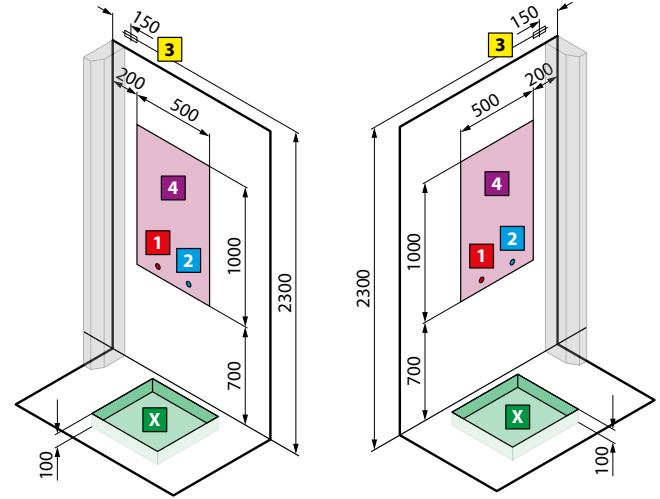

Version **Links**

Version **Rechts**

für mod. **A100x80**

für mod. **A100x80 - 2P120x80**

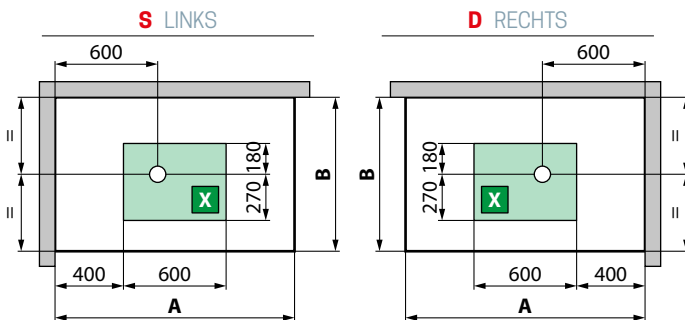

Modelle	A ± 3	B ± 3
2P140x80	1394	794
2P140x90	1394	894

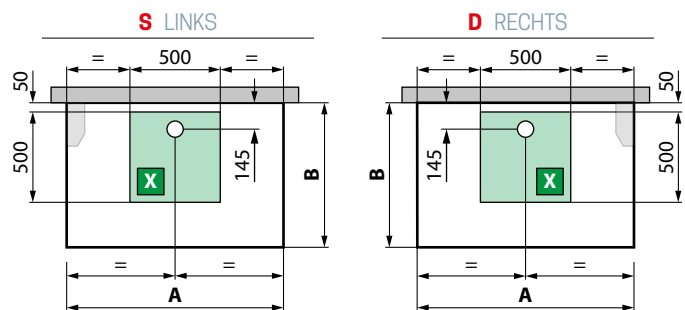

Modelle	A ± 3	B ± 3
A+F100x80	996	796
2P+2F120x80	1196	796

TECHNISCHE EIGENSCHAFTEN:
 Optimaler dynamischer Druck 2÷5 bar
 Warmwasseranschluss 1/2"
 Kaltwasseranschluss 1/2"
 Syphonanschluss ø 40 mm

ELEKTRISCHE ANSCHLUSSWERTE:
 Spannung 220 - 230 V
 Frequenz 50/60 Hz
 Max. Leistungsaufnahme: 2600 W
 Nennleistung: 2500 W

ACHTUNG! Vor der Installation der elektrischen Anlage muss ein 30mA Differentialschalter mit allpoliger Schaltereinheit eingebaut werden, mit einer Öffnung der Kontakte von mindestens 3 mm.

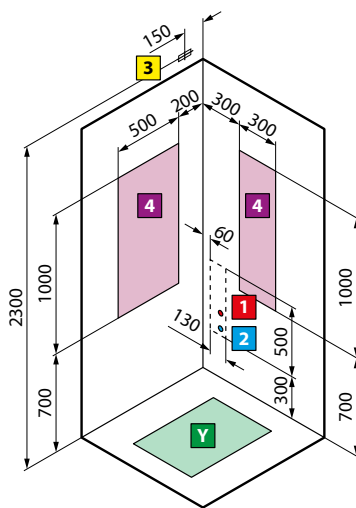
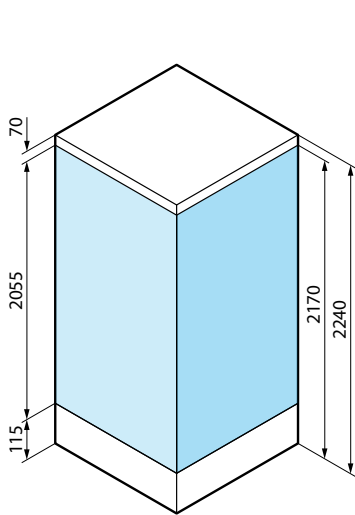

für Modelle
A80 - A90 - A100 - GF80 - GF90 - R90 - R100

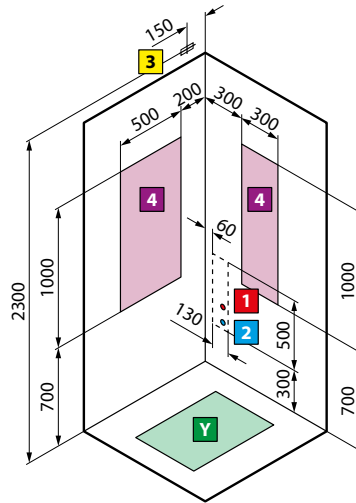

Version Rechts **Version Links**
für mod. **A90x70 - A100x70 - A100x80 - 2P120x80 - 2P120x90**

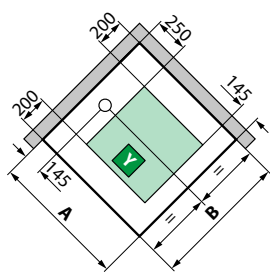

Modelle	A ± 3	B ± 3
A80	796	796
A90	896	896
A100	996	996
GF80	796	796
GF90	896	896

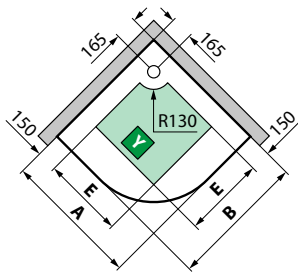

Modelle	A ± 3	B ± 3
R90	896	896
R100	996	996

S LINKS

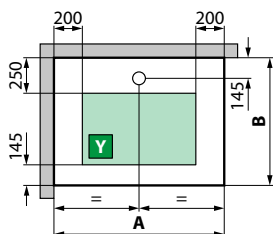

D RECHTS

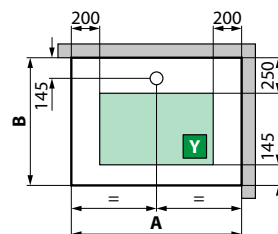

Modelle	A ± 3	B ± 3
A90x70	896	696
A100x70	996	696
A100x80	996	796
2P120x80	1196	796
2P120x90	1196	896

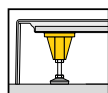
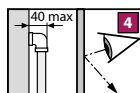
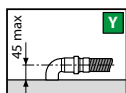

Brausetasse ohne
Inspektionspaneel

ACHTUNG!
Kann für Personen
mit Herzschrittmacher
gefährlich sein.

GLAX 2.0 DUSCHWANNEN 125 MM TECHNISCHE SKIZZEN

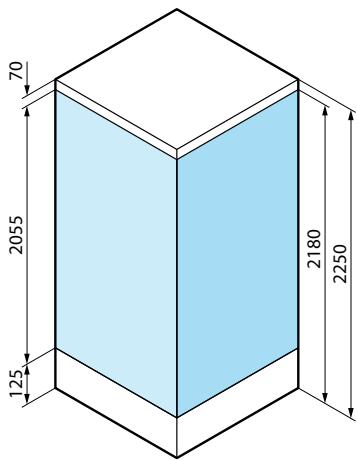

Version **Links**

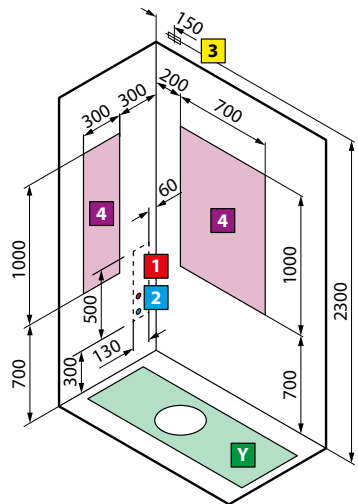

Version **Rechts**

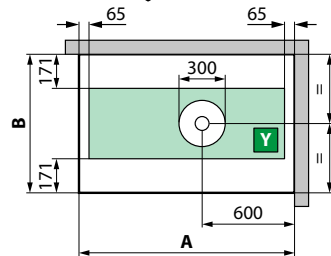
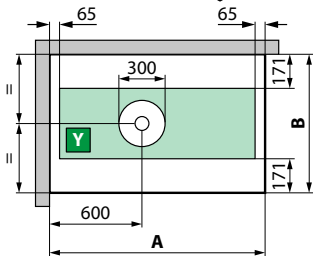
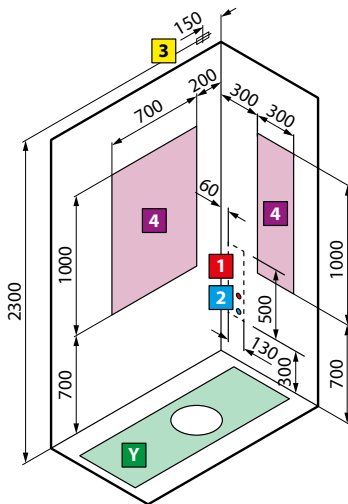

Modelle	A ± 3	B ± 3
2P140x80	1398	798
2P140x90	1398	898

GLAX 2.0 DUSCHWANNEN 115 MM

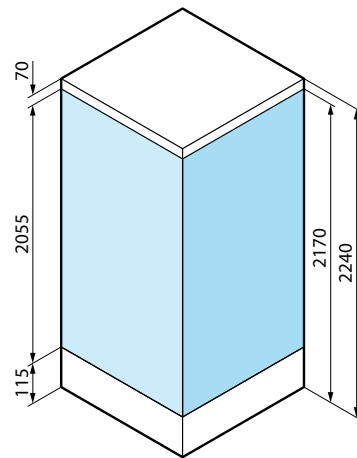

Version **Links**

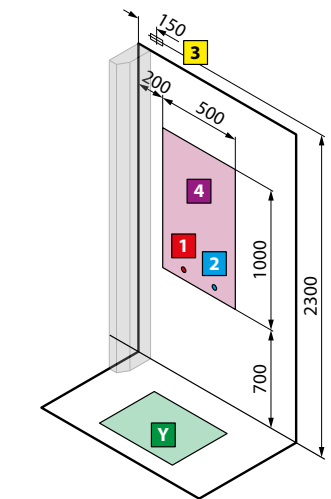

Version **Rechts**

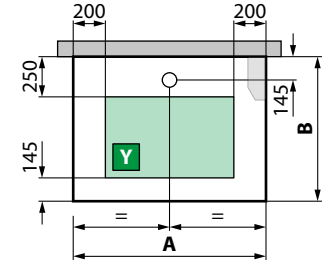
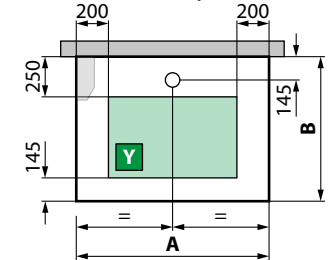
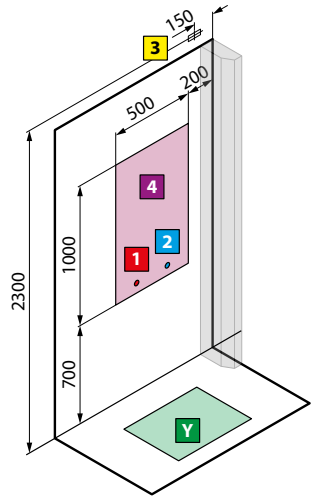

Modelle	A ± 4	B ± 4
A+F100x80	998	798
2P+2F120x80	1198	798

TECHNISCHE EIGENSCHAFTEN:
 Optimaler dynamischer Druck 2-5 bar
 Warmwasseranschluss 1/2"
 Kaltwasseranschluss 1/2"
 Syphonanschluss ø 40 mm

ELEKTRISCHE ANSCHLUSSWERTE:
 Spannung 220 - 230 V
 Frequenz 50/60 Hz
 Max. Leistungsaufnahme: 2600 W
 Nennleistung: 2500 W

ACHTUNG! Vor der Installation der elektrischen Anlage muss ein 30mA Differentialschalter mit allpoliger Schaltereinheit eingebaut werden, mit einer Öffnung der Kontakte von mindestens 3 mm.

TECHNISCHE SKIZZEN