

# PERIMETRO

Modularità / Modularity

**Basi Portalavabo/lavatoio/consolle**  
Base unit for tabletop washbasin/wash sink/console

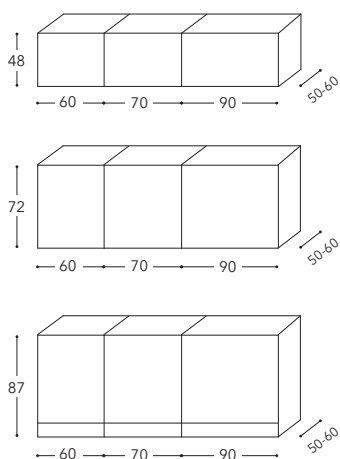

**Basi laterali**  
Lateral bases

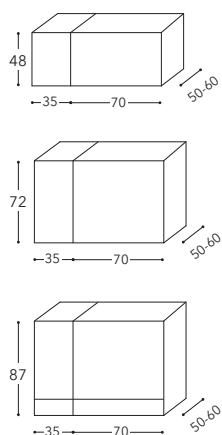

**Basi accessoriabili**  
Equipped bases

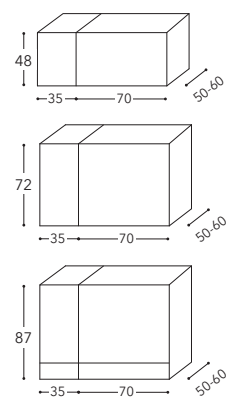

**Basi Portalavabo/lavatoio**  
Base unit for tabletop washbasin/wash sink

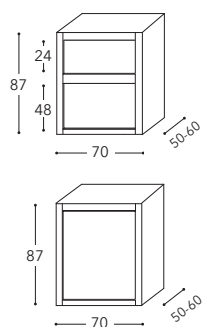

**Basi porta lavatrice/asciugatrice**  
Base unit for washing machine/drier unit

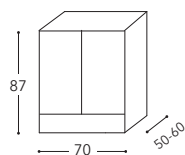

# PERIMETRO

Modularità / Modularity

**Pensili**  
Wall unit

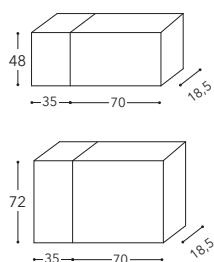

**Pensili con chiave**  
Wall unit with key

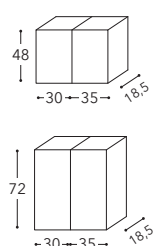

**Mensole a misura**  
Shelves to size

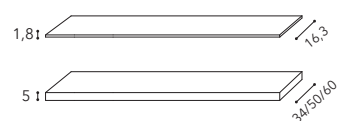

**Colonne**  
Columns

**Porta asse da stiro e porta scope**  
Ironing board holder and broom holder

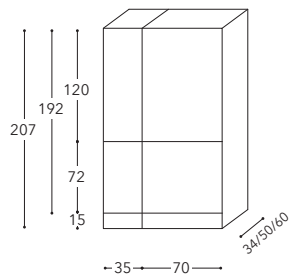

**Accessoribili**  
Equipped

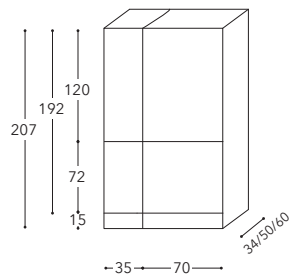

**Con ripiani in vetro**  
With glass shelves

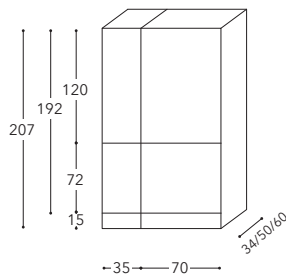

**4 ante per lavatrice**  
4 doors for washing-machine

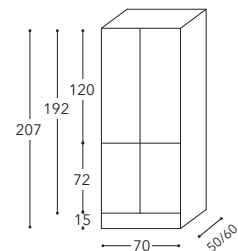

**4 ante per lavatrice / asciugatrice**  
4 doors for washing-machine / drier unit

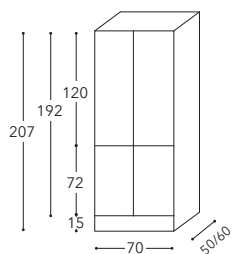

**A giorno per lavatrice**  
Open unit for washing machine

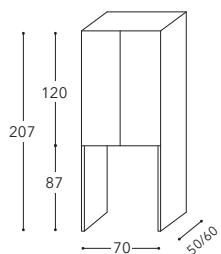

**4 ante + 1 cassetto con stendino**  
4 doors + 1 drawer with clothes horse

